

Design Envelope 4322 & 4372 Tango Pumping Unit

With iECM 1-10 HP Motor

Quick Installation guide

File No: 102.81
Date: AUGUST 14, 2017
Supersedes: 102.81
Date: MAY 10, 2017

1.0 TOOLS YOU WILL NEED



2.0 HANDLING

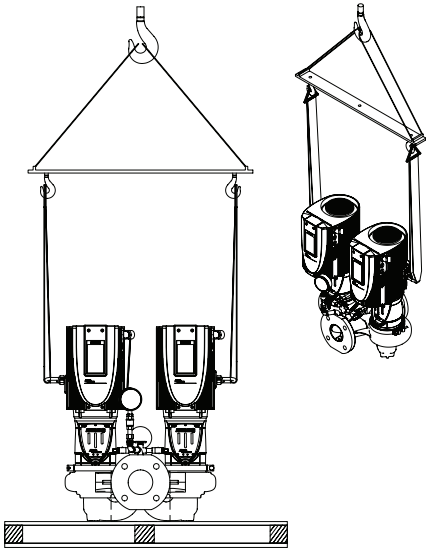

3.0 INSTALLATION

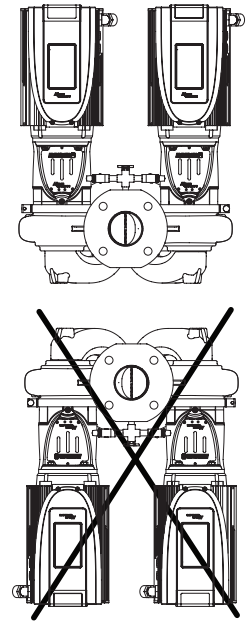
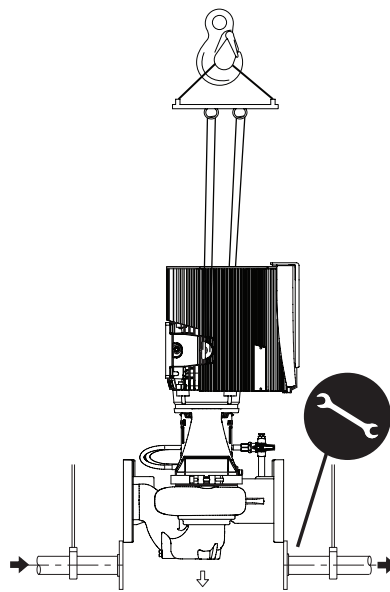

4.0 POWER WIRING

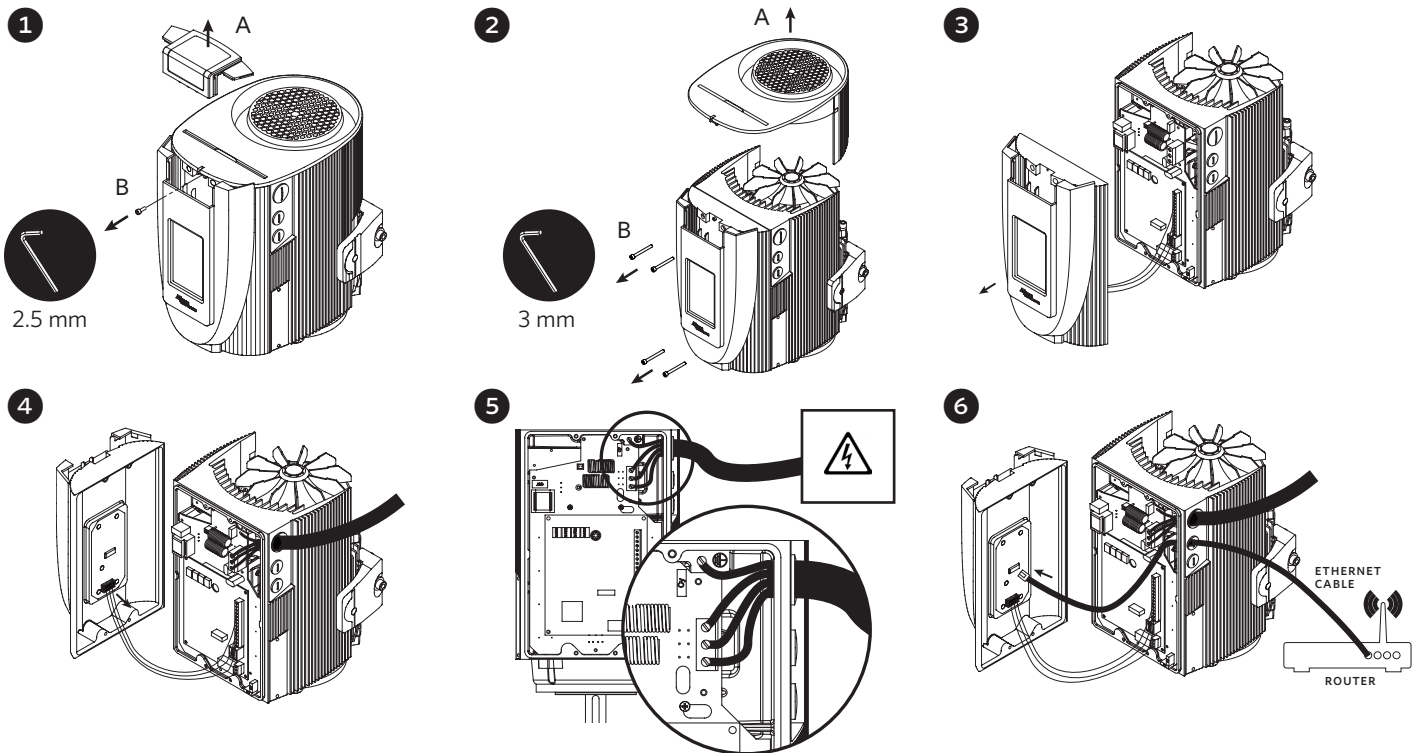

5.0 TOUCHSCREEN LOGIN (SET BOTH CONTROL SCREENS)

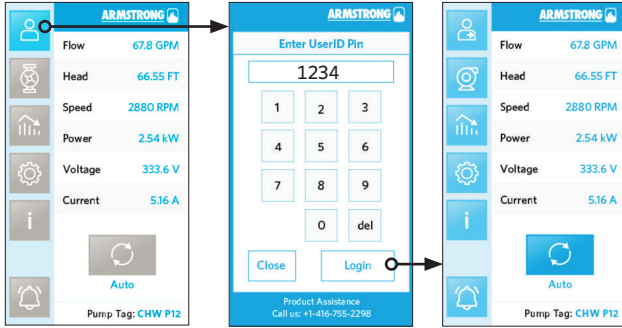

6.0 NETWORKING OPTIONS

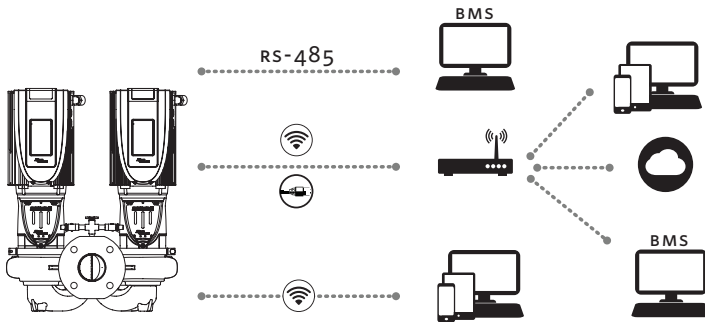

6.1 CONNECTING TO THE ROUTER

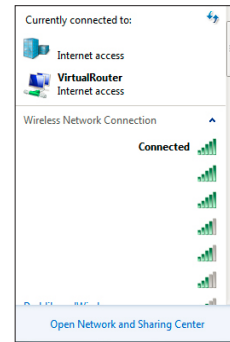

6.2 CONNECTING VIA WEB BROWSER (SET BOTH CONTROL SCREENS)

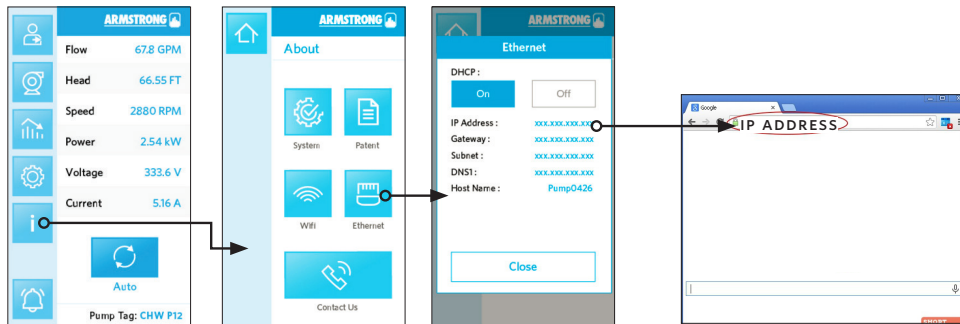

7.0 SETTING DESIGN POINT (SET BOTH CONTROL SCREENS)

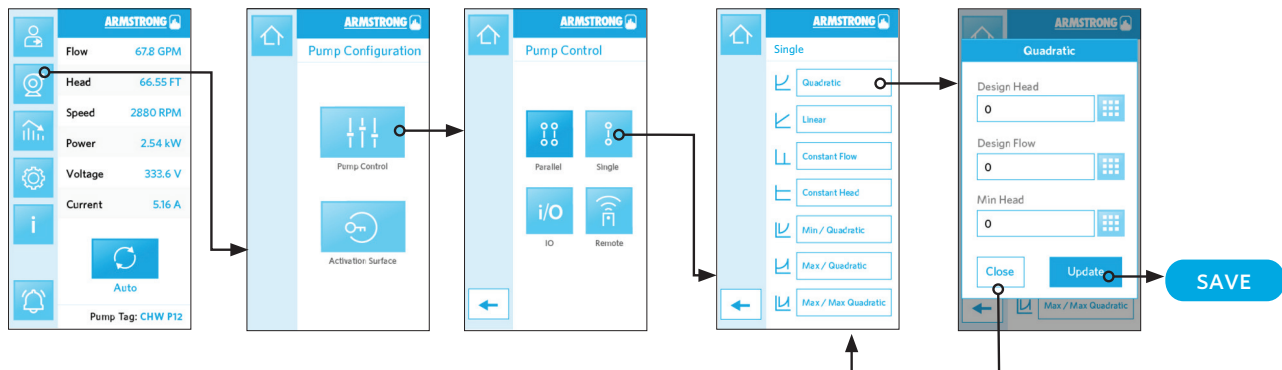

8.0 HAND MODE

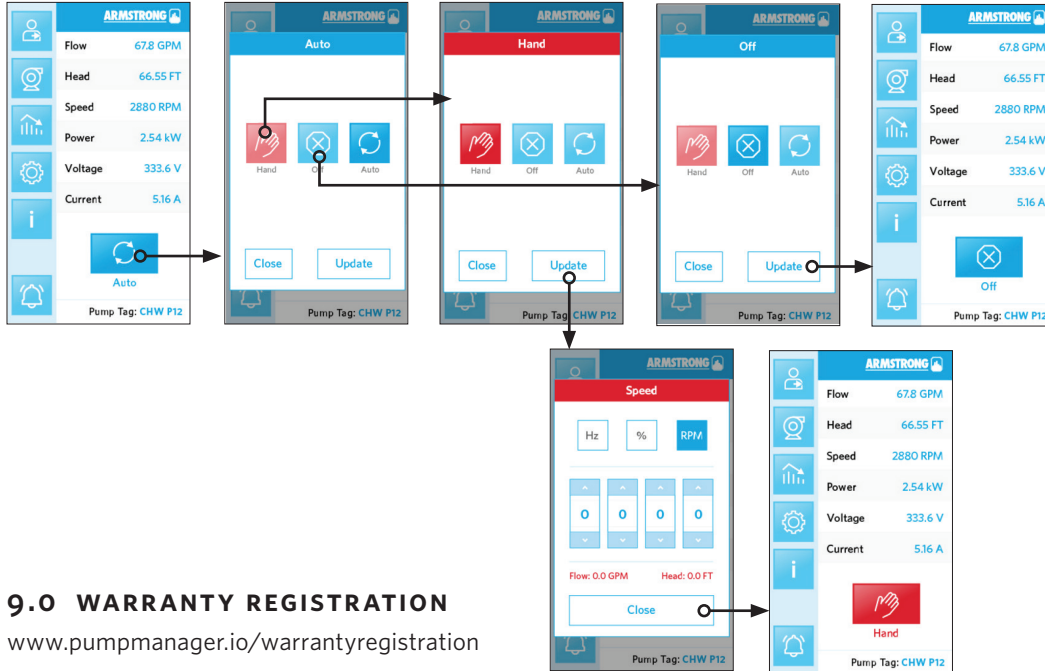

9.0 WARRANTY REGISTRATION

www.pumpmanager.io/warrantyregistration

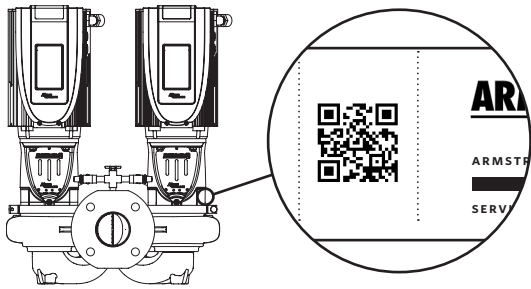

TORONTO

+1 416 755 2291

BUFFALO

+1 716 693 8813

BIRMINGHAM

+44 (0) 8444 145 145

MANCHESTER

+44 (0) 8444 145 145

BANGALORE

+91 (0) 80 4906 3555

SHANGHAI

+86 21 3756 6696

SÃO PAULO

+55 11 4781 5500