

Design Envelope 4200H & 4280

End suction horizontal
pumping unit with
IVS drive

Quick Installation guide

File No: 103.83
Date: MARCH 09, 2018
Supersedes: NEW
Date: NEW

1.0 TOOLS YOU WILL NEED



2.0 HANDLING

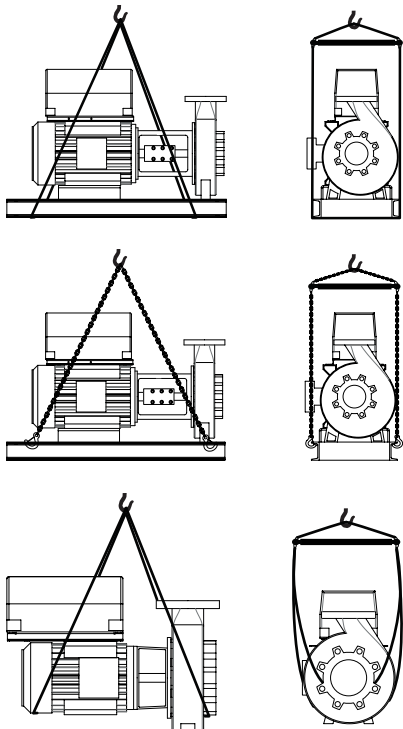

3.0 INSTALLATION

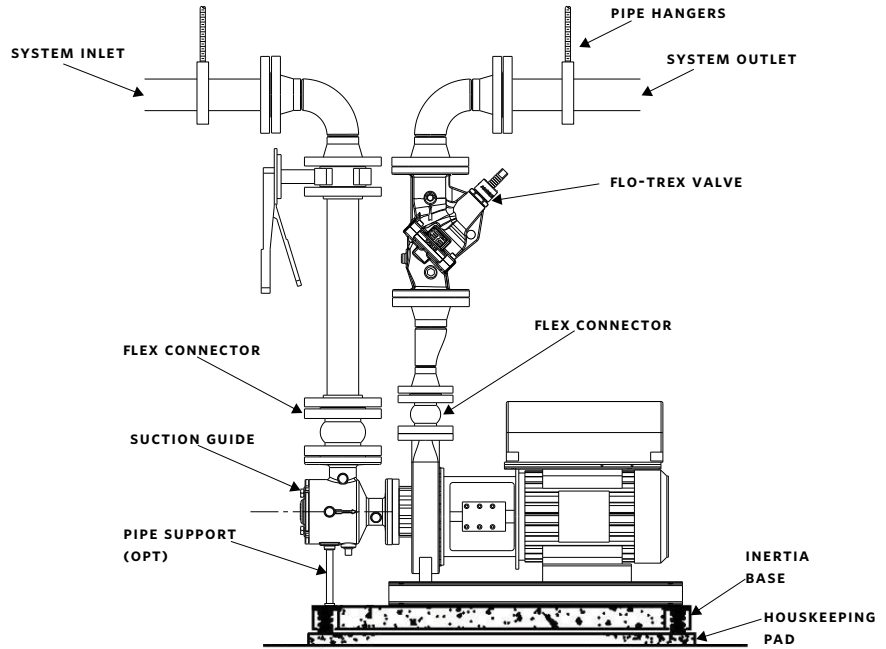

4.0 POWER WIRING

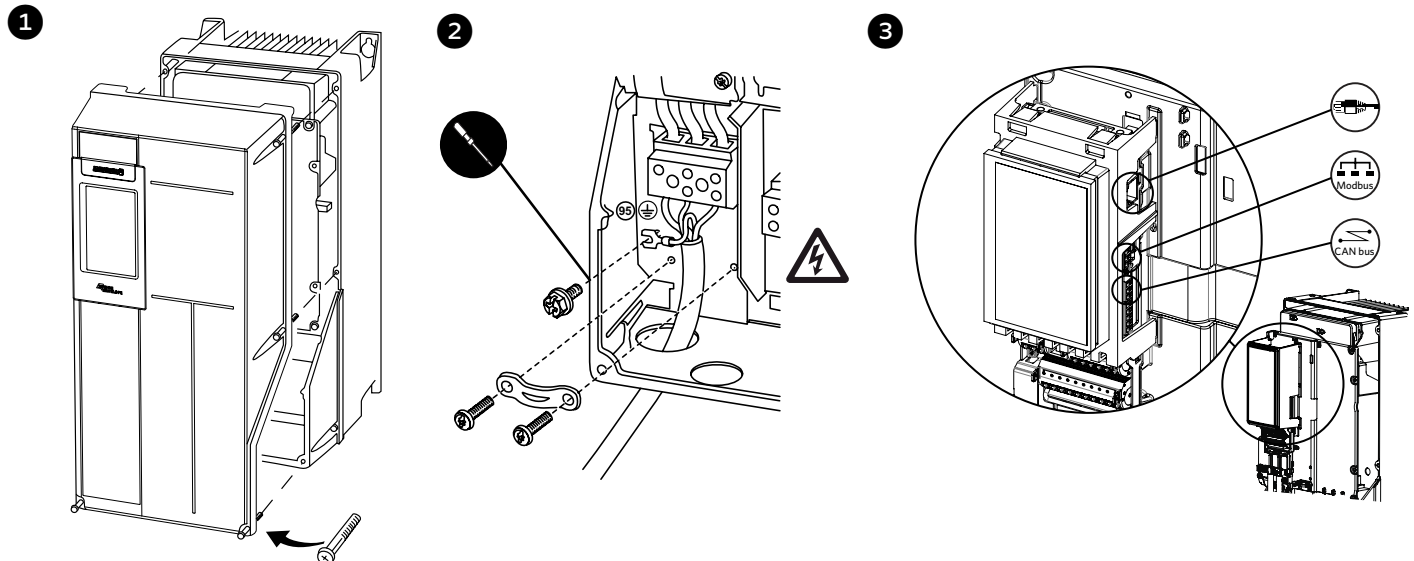

5.0 TOUCHSCREEN LOGIN

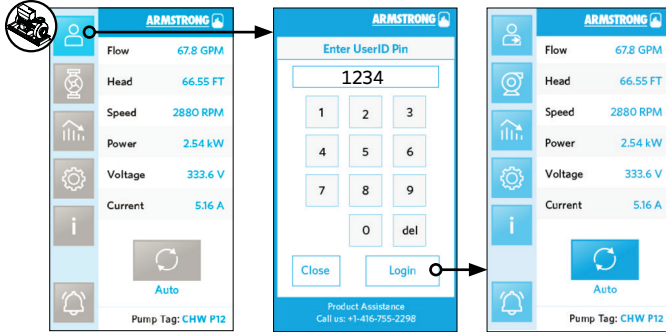

6.0 NETWORKING OPTIONS

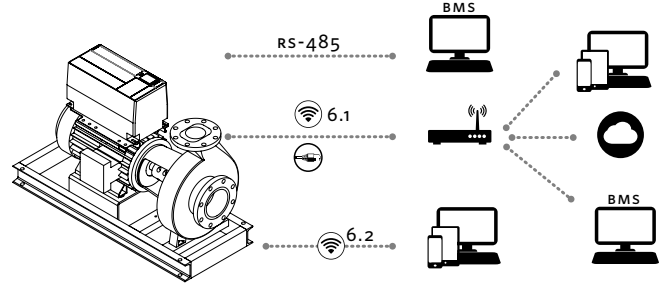

6.1 CONNECTING TO THE ROUTER

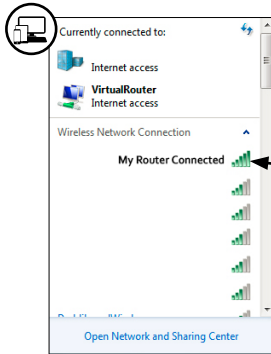

6.2 CONNECTING TO WIFI

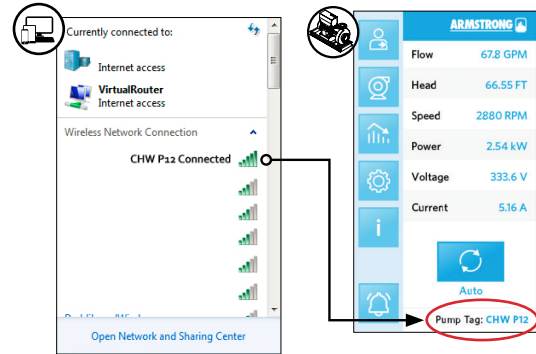

6.2 CONNECTING VIA WEB BROWSER

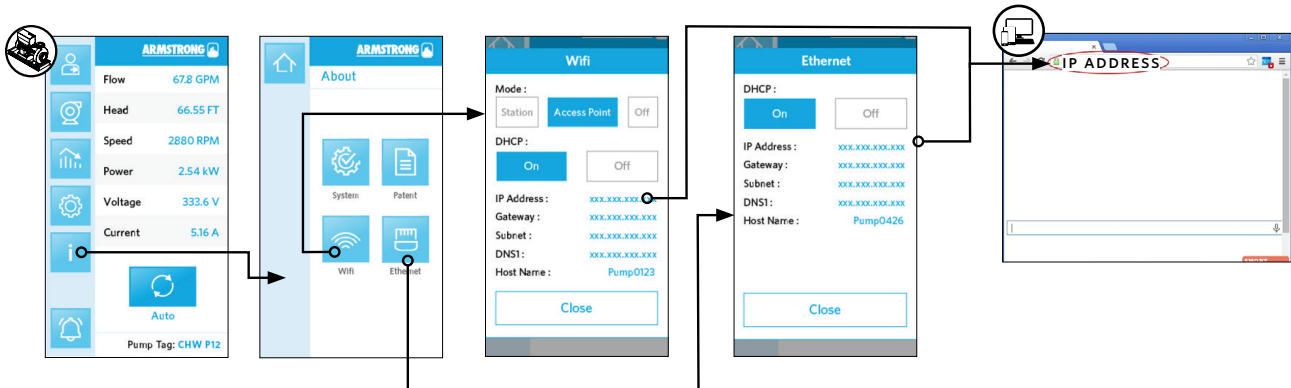

7.0 SETTING DESIGN POINT

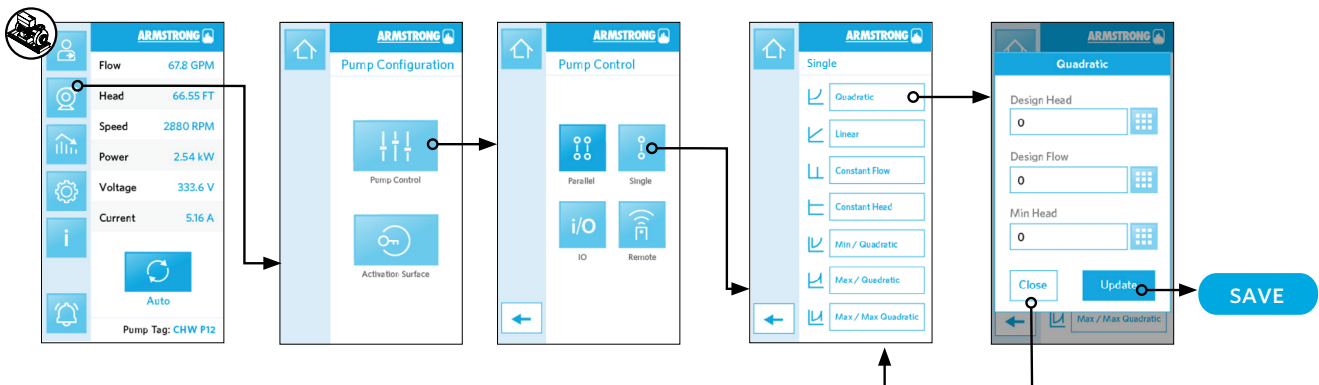

8.0 HAND MODE AND OFF MODE

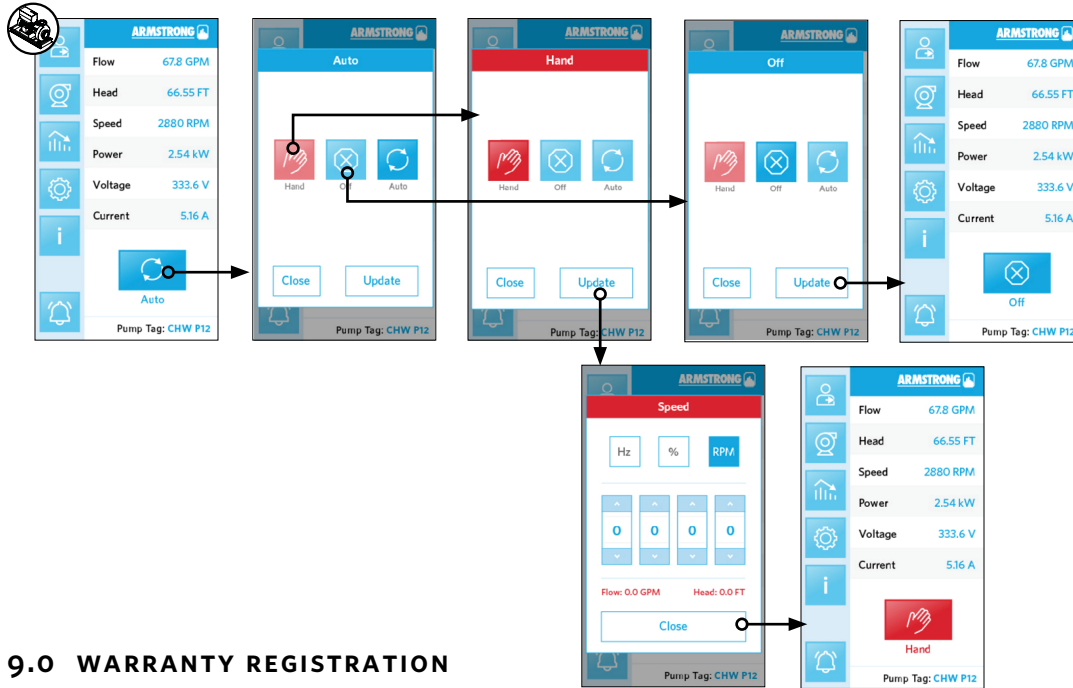

9.0 WARRANTY REGISTRATION

www.armstrongfluidtechnology.com/warrantyregistration

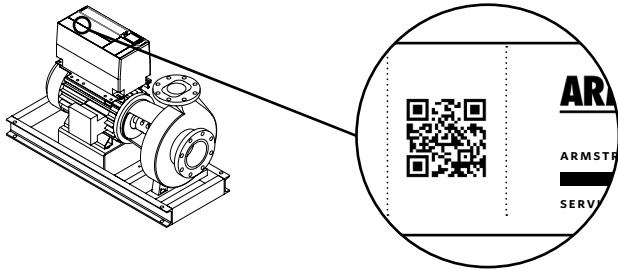

TORONTO

+1 416 755 2291

BUFFALO

+1 716 693 8813

BIRMINGHAM

+44 (0) 8444 145 145

MANCHESTER

+44 (0) 8444 145 145

BANGALORE

+91 (0) 80 4906 3555

SHANGHAI

+86 21 3756 6696

SÃO PAULO

+55 11 4781 5500