

Contents

1 Copyright	3
Copyright	3
Copyright, Limitation of Liability and Revision Rights	3
2 Safety	4
Safety	4
3 Introduction	6
Introduction	6
4 How to install	9
How to install	9
5 Configuration of the system	16
Configuring the System	16
Network Variable Description	19
VSD 6010 Profile	31
Network Variable Description - VSD Profile - input	32
Network Variable Description - VSD Profile - Output	33
Network Variable Description - VSD Profile - Configuration	34
Node Object	36
Network Timer Functions	37
6 How to control the Frequency Converter	38
How to Control the IVS 102	38
Open Loop	38
Closed Loop	38
Armstrong IVS Control Profile	39
7 How to access IVS 102 parameters	42
User-defined Network Variables UNVT	42
8 Parameters	46
Parameter list	46
Parameter Group 8-**	46
Parameter Group 11	51
Data Types Supported by IVS 102	52
9 Troubleshooting	53
Alarm-, Warning and Extended Status Word	53
Alarm words	54
Warning words	55
Extended Status Word	56

Extended status words	56
Reference Scaling - Examples	57
Network Variables - Overview	58
Index	60

1 Copyright

1

1.1 Copyright

1.1.1 Copyright, Limitation of Liability and Revision Rights

This publication contains information proprietary to Armstrong. By accepting and using this manual the user agrees that the information contained herein will be used solely for operating equipment from Armstrong or equipment from other vendors provided that such equipment is intended for communication with Armstrong equipment over a serial communication link. This publication is protected under the Copyright laws of Denmark and most other countries.

Armstrong does not warrant that a software program produced according to the guidelines provided in this manual will function properly in every physical, hardware or software environment.

Although Armstrong has tested and reviewed the documentation within this manual, Armstrong makes no warranty or representation, neither expressed nor implied, with respect to this documentation, including its quality, performance, or fitness for a particular purpose.

In no event shall Armstrong be liable for direct, indirect, special, incidental, or consequential damages arising out of the use, or the inability to use information contained in this manual, even if advised of the possibility of such damages. In particular, Armstrong is not responsible for any costs, including but not limited to those incurred as a result of lost profits or revenue, loss or damage of equipment, loss of computer programs, loss of data, the costs to substitute these, or any claims by third parties.

Armstrong reserves the right to revise this publication at any time and to make changes to its contents without prior notice or any obligation to notify former or present users of such revisions or changes.

2 Safety

2.1 Safety

2.1.1 Safety note

2



The voltage of the frequency converter is dangerous whenever connected to mains. Incorrect installation of the motor, frequency converter or fieldbus may cause damage to the equipment, serious personal injury or death. Consequently, the instructions in this manual, as well as national and local rules and safety regulations, must be complied with.

Safety Regulations

1. The frequency converter must be disconnected from mains if repair work is to be carried out. Check that the mains supply has been disconnected and that the necessary time has passed before removing motor and mains plugs.
2. The [STOP/RESET] key on the LCP of the frequency converter does not disconnect the equipment from mains and is thus not to be used as a safety switch.
3. Correct protective earthing of the equipment must be established, the user must be protected against supply voltage, and the motor must be protected against overload in accordance with applicable national and local regulations.
4. The earth leakage currents are higher than 3.5 mA.
5. Protection against motor overload is set by par. 1-90 *Motor Thermal Protection*. If this function is desired, set par. 1-90 *Motor Thermal Protection* to data value [ETR trip] (default value) or data value [ETR warning]. Note: The function is initialised at 1.16 x rated motor current and rated motor frequency. For the North American market: The ETR functions provide class 20 motor overload protection in accordance with NEC.
6. Do not remove the plugs for the motor and mains supply while the frequency converter is connected to mains. Check that the mains supply has been disconnected and that the necessary time has passed before removing motor and mains plugs.
7. Please note that the frequency converter has more voltage inputs than L1, L2 and L3, when load sharing (linking of DC intermediate circuit) and external 24 V DC have been installed. Check that all voltage inputs have been disconnected and that the necessary time has passed before commencing repair work.

Installation at High Altitudes



Installation at high altitude:

380 - 500 V, enclosure A, B and C: At altitudes above 2 km, please contact Armstrong regarding PELV.
 380 - 500 V, enclosure D, E and F: At altitudes above 3 km, please contact Armstrong regarding PELV.
 525 - 690 V: At altitudes above 2 km, please contact Armstrong regarding PELV.

Warning against Unintended Start

1. The motor can be brought to a stop by means of digital commands, bus commands, references or a local stop, while the frequency converter is connected to mains. If personal safety considerations make it necessary to ensure that no unintended start occurs, these stop functions are not sufficient.
2. While parameters are being changed, the motor may start. Consequently, the stop key [STOP/RESET] must always be activated; following which data can be modified.
3. A motor that has been stopped may start if faults occur in the electronics of the frequency converter, or if a temporary overload or a fault in the supply mains or the motor connection ceases.



Warning :

Touching the electrical parts may be fatal - even after the equipment has been disconnected from mains.

Also make sure that other voltage inputs have been disconnected, such as external 24 V DC, load sharing (linkage of DC intermediate circuit), as well as the motor connection for kinetic back up. Refer to the Operating Instructions for further safety guidelines.

2.1.2 Safety Regulations

1. The frequency converter must be disconnected from mains if repair work is to be carried out. Check that the mains supply has been disconnected and that the necessary time has passed before removing motor and mains plugs.
2. The [STOP/RESET] key on the LCP of the frequency converter does not disconnect the equipment from mains and is thus not to be used as a safety switch.
3. Correct protective earthing of the equipment must be established, the user must be protected against supply voltage, and the motor must be protected against overload in accordance with applicable national and local regulations.
4. The earth leakage currents are higher than 3.5 mA.
5. Protection against motor overload is not included in the factory setting. If this function is desired, set par. 1-90 *Motor Thermal Protection* to data value ETR trip or data value ETR warning. Note: The function is initialised at 1.16 x rated motor current and rated motor frequency. For the North American market: The ETR functions provide class 20 motor overload protection in accordance with NEC.
6. Do not remove the plugs for the motor and mains supply while the frequency converter is connected to mains. Check that the mains supply has been disconnected and that the necessary time has passed before removing motor and mains plugs.
7. Please note that the frequency converter has more voltage inputs than L1, L2 and L3, when load sharing (linking of DC intermediate circuit) and external 24 V DC have been installed. Check that all voltage inputs have been disconnected and that the necessary time has passed before commencing repair work.

2.1.3 Warning against Unintended Start

1. The motor can be brought to a stop by means of digital commands, bus commands, references or a local stop, while the frequency converter is connected to mains. If personal safety considerations make it necessary to ensure that no unintended start occurs, these stop functions are not sufficient.
2. While parameters are being changed, the motor may start. Consequently, the stop key [STOP/RESET] must always be activated; following which data can be modified.
3. A motor that has been stopped may start if faults occur in the electronics of the frequency converter, or if a temporary overload or a fault in the supply mains or the motor connection ceases.



Touching the electrical parts may be fatal - even after the equipment has been disconnected from mains.

Also make sure that other voltage inputs have been disconnected, such as external 24 V DC, load sharing (linkage of DC intermediate circuit), as well as the motor connection for kinetic back up. Refer to *IVS 102 Drive Operating Instructions (MG.11.AX.YY)* for further safety guidelines.

3 Introduction

3.1 Introduction

3.1.1 About this manual

First time users can obtain the most essential information for quick installation and set-up in these chapters:

- Introduction
- How to Install
- How to Configure the System

For more detailed information including the full range of set-up options and diagnosis tools please refer to the chapters:

- How to Control the IVS 102
- How to Access IVS 102 Parameters
- Parameters
- Troubleshooting

Echelon®, LonTalk®, Neuron®, LonWorks® and LonMaker® are registered trademarks of the Echelon Corporation.

3.1.2 Technical Overview

The LonWorks communications structure is similar to that of a local area network (LAN) in that messages are continually exchanged between a number of processors. A LonWorks system is a local operating network (LON). LON technology offers a means for integrating various distributed systems that perform sensing, monitoring, control, and other automated functions. A LON allows these intelligent devices to communicate with one another through a variety of communications media using a standard protocol.

LON technology supports distributed, peer-to-peer communications. That is, individual network devices can communicate directly with one another without the need for a central control system. A LON is designed to move sense and control messages which are typically very short and which contain commands and status information that trigger actions. LON performance is viewed in terms of transactions completed per second and response time. Control systems do not require vast amounts of data, but they do demand that the messages they send and receive are absolutely correct.

Data are transported by means of standard network variable types (SNVTs) which provide a well-defined interface for communication between devices from different manufacturers. Functional profiles defining the functionality and network variables for a particular family of devices (e.g. frequency converters, pumps etc.) are also available, and supported by the LonWorks option.

3.1.3 Assumptions

These operating instructions assume, that the Armstrong LonWorks option is used in conjunction with a Armstrong IVS 102 frequency converter. It is also assumed that the installed controller supports the interfaces described in this document and that all the requirements stipulated in the controller, as well as the frequency converter, are strictly observed along with all limitations therein.

3.1.4 Hardware

This manual relates to the *LonWorks option MCA108*, type no. 130B1106 (non-coated) and 130B1206 (coated).

3.1.5 Background Knowledge

The Armstrong LonWorks Option Card is designed to communicate with any system complying with the FTT and 78Kbps LonWorks standard. Familiarity with this technology is assumed. Issues regarding hardware or software produced by other manufacturers, including commissioning tools, are beyond the scope of this manual and are not the responsibility of Armstrong.

For information regarding commissioning tools or communication with a non-Armstrong node, please consult the appropriate manuals.

3

3.1.6 Related Literature for the IVS 102 Drive

Title	Literature no.
IVS 102 Drive Operating Instructions	MG.11.Ax.yy
IVS 102 Drive Design Guide	MG.11.Bx.yy
IVS 102 Drive Programming Guide	MG.11.Cx.yy

The following literature is available for the IVS 102 series:

Please also refer to www.armstrongintegrated.com/BusinessAreas/DrivesSolution for additional information.

3.1.7 LonMark Certification

The LonWorks option is conform to the LonMark standards and is certified towards LonMark ver. 3.4



3.1.8 Abbreviations

ACK	AC Knowledge
A	Ampere
BOOL	Boolean
CC	Control Card
CTW	Control Word
EMC	Electromagnetic Compatibility
FTT	Free Topology Transceiver
HF	High frequency
Hz	Frequency in Hertz
I/O	Input / Output
IRMS	Output Current Mean Value
LCP	Local Control Panel
LED	Light Emitting Diode
LON	Local Area Network
LSB	Least Significant Bit
MAV	Main Active Value
MSB	Most Significant Bit
MRV	Main Reference Value
N/A	Not Applicable
PC	Personal Computer
PLC	Programmable Logic Controller
PNU	Parameter Number
RPM	Revolutions Per Minute
RTC	Real Time Clock
s	Seconds
SCPT	Standard Configuration Property Types
SNVT	Standard Network Variable Type
SINT	Signed integer
STW	Status Word
V	Voltage
VSD	Variable Speed Drive
UDINT	Unsigned double integer
UINT	Unsigned integer
UNVT	User-defined Network Variable Type
XIF	Extended Interface File

4 How to install

4.1 How to install

4.1.1 The LonWorks Option

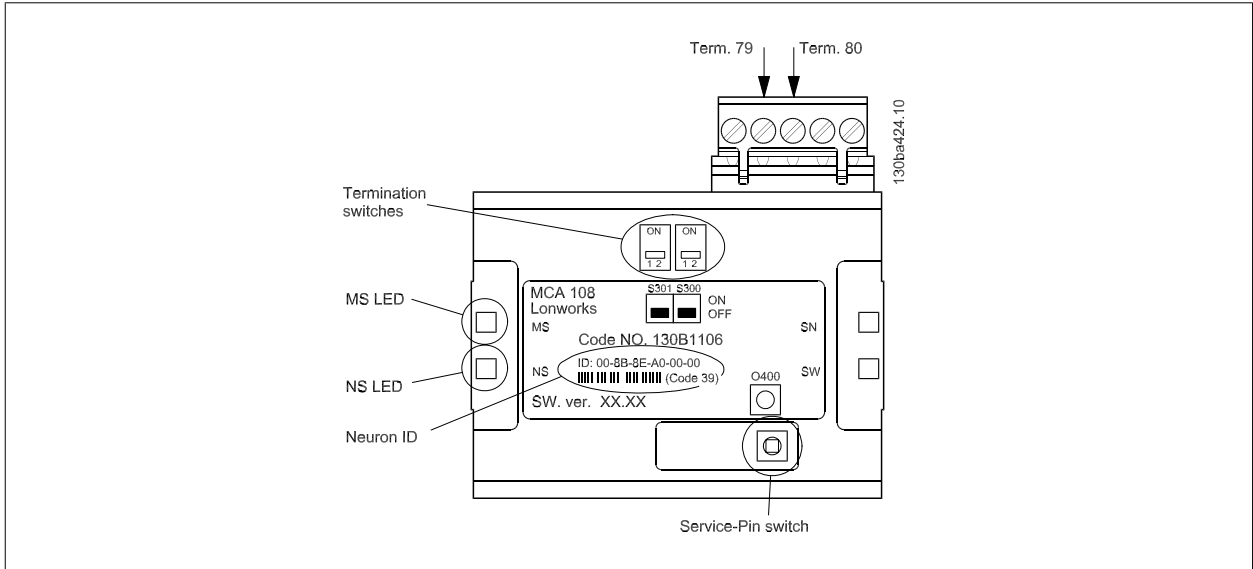

The LonWorks option is equipped with two termination switches, S300 and S301, enabling double termination when using bus topology.

The push-button switch O400, activates the Service-Pin function.

The LEDs:

LED label	Description
MS	Service LED (red)
NS	Status LED (green)

The neuron ID is printed on the option in text and in barcode (code 39).

4.1.2 Cabling

The Free Topology Transceiver (FTT) system is designed to support free topology wiring and accommodates bus, star, loop or any combination of these topologies.

The LonWorks option is equipped with the FT-X1 transceiver for improved EMC performance. Flexible wiring capability simplifies system installation and makes it easy to add nodes for system expansion.

The figures below illustrate five different network topologies.

4

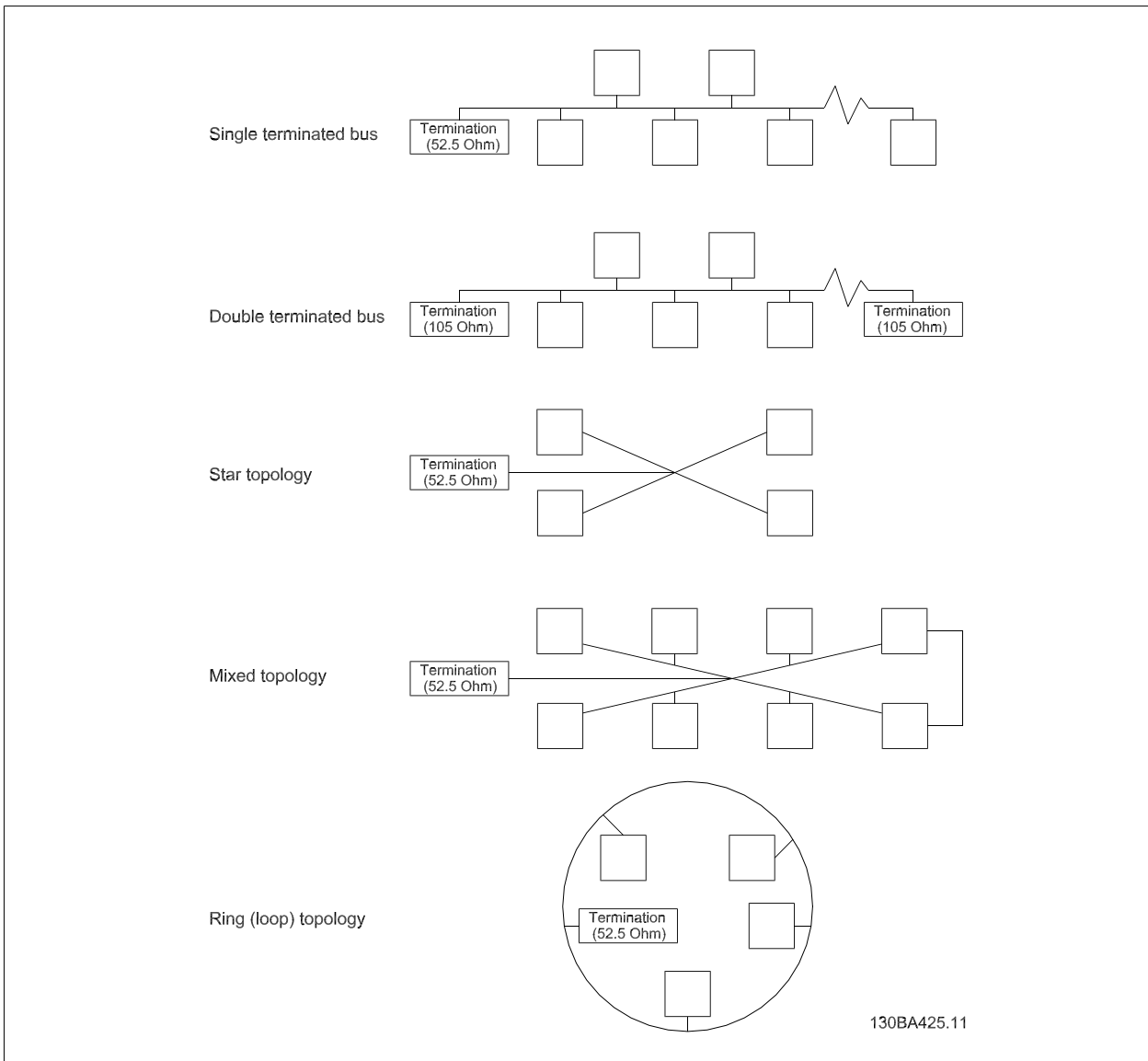

4.1.3 Network Termination

Dependent on the type of topology, at least one of the connected nodes must be terminated (52.5Ω). The option has two built-in termination circuits which are activated by the terminator switches S300 and S301.

If termination is provided elsewhere in the network, the termination switches should be OFF. If a double-terminated bus topology is used, the first and the last node should be double-terminated (105Ω).

Termination switch positions are shown in the table below.

Termination type	S 300	S 301
No termination (factory setting)	OFF	OFF
Double termination (105 Ω)	ON	OFF
Single termination (52.5 Ω)	ON	ON

4.1.4 Connecting the Bus Line

Connect bus wire NET A to terminal 79 and NET B to 80 of the terminal connector.

Terminal	Connection
79	NET A*
80	NET B*
61	Drain**



NB!
***Note:** For free topology wiring the option is insensitive to the polarity of the bus-terminals.



NB!
****Note:** Term. 61 (Drain) offers a RC-junction to ground and should not be used for grounding of shielded cable. Ground the shielded cable at the de-coupling plate by removing cable insulation at contact point.

4.1.5 Maximum Cable Lengths

Network topology	Maximum cable length
Free topology without repeater	500 m
Free topology with one repeater	1000 m
Free topology maximum device-to-device	500 m
Bus topology single terminated	500 m
Bus topology double terminated without repeater	2700 m
Bus topology double terminated with one repeater	5400 m
Bus topology maximum stub length	3 m

Use of the same cable type throughout the entire network is recommended in order to avoid impedance mismatch.

4.1.6 System Specifications

Up to 64 FT-X1/FTT-10 transceivers, are allowed per network segment.



NB!
Note: The Free Topology LonWorks runs at 78 Kbps only.

4.1.7 EMC Precautions

The following EMC precautions are recommended in order to achieve interference-free operation of the LonWorks network. Additional EMC information is available in the *IVS 102 Drive Design Guide*.



NB!

N.B.:

Relevant national and local regulations, for example regarding protective earth connection, must be observed.

4

The LonWorks communication cable must be kept away from motor and brake resistor cables to avoid coupling of high frequency noise from one cable to the other. Normally a distance of 200 mm (8 inches) is sufficient, but maintaining the greatest possible distance between the cables is recommended, especially where cables run in parallel over long distances. When crossing is unavoidable, the LonWorks cable must cross motor and brake resistor cables at an angle of 90 degrees.

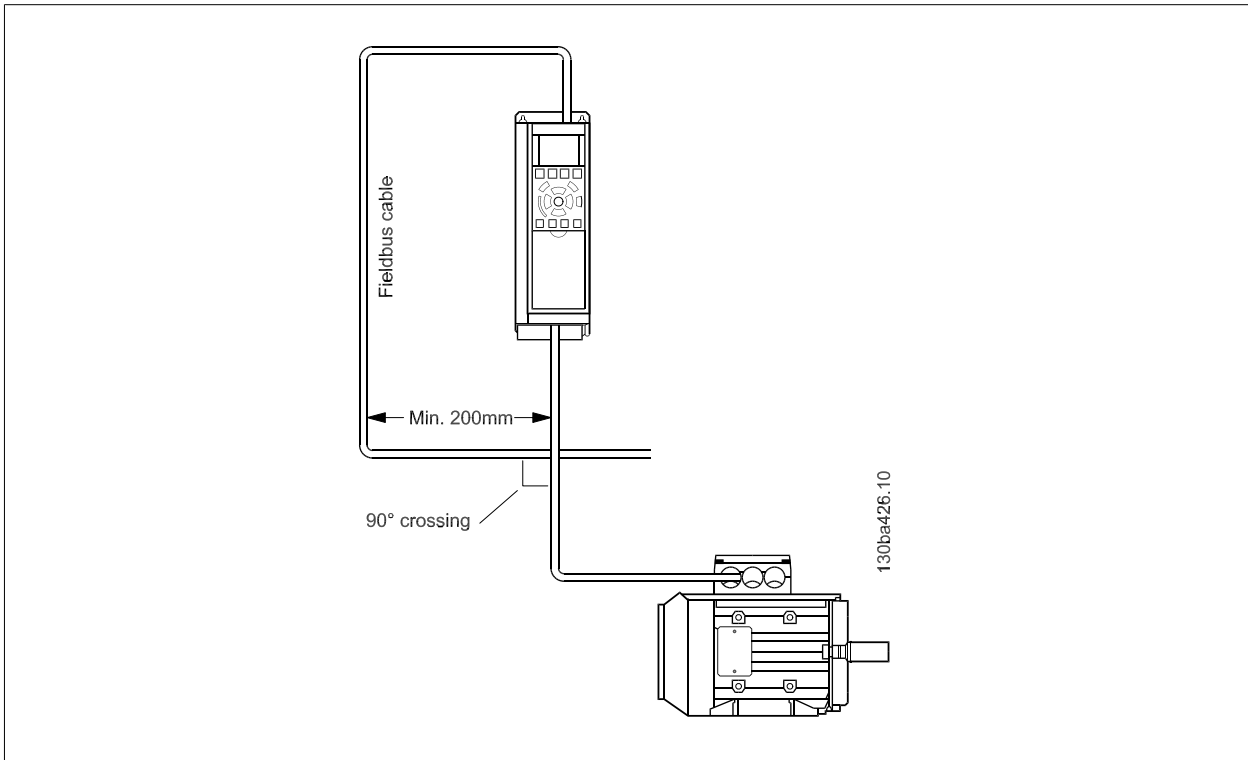

NB!

It is highly recommended to use suitable screened cable for any LonWorks installation!

4.1.8 LED Behaviour

MS: Service LED (red)

Situation	LED	Description
Configured state (Normal operation)		1/2 sec. ON, then continuously OFF The node is configured and running normally
Non configured state		Flashing 1/2 Hz Node is not configured but has an application. Proceed with loading node.
Applicationless state		1 sec. ON, 2 sec. OFF, then continuously ON Node has no application, the LonWorks option needs replacing or reprogramming
Watchdog resets		Short flash about every 3 sec. Indicates problem with application. The LonWorks option needs replacing
Faulty hardware		Steady ON or OFF The LonWorks option needs replacing

NS: Status LED (green)

Situation	LED	Description
Node configured		Steady ON The node is configured and running normally
Wink service		Flashing 1/2 Hz for 20 sec. Wink service activated in order to identify node.

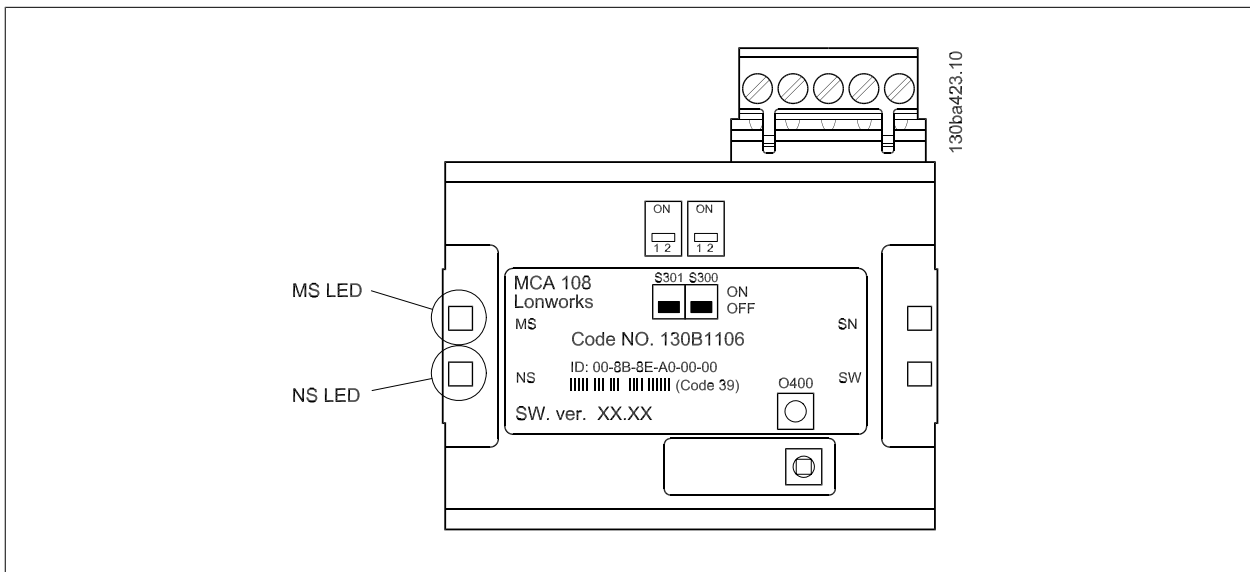

4.1.9 How to Install Option in Frequency Converter

Items required to install a fieldbus option in the frequency converter:

- The fieldbus option
- Fieldbus option adaptor frame for the IVS 102. This frame is deeper than the standard frame, to allow space for the fieldbus option beneath
- Decoupling plate (only for A1 and A2 enclosures)

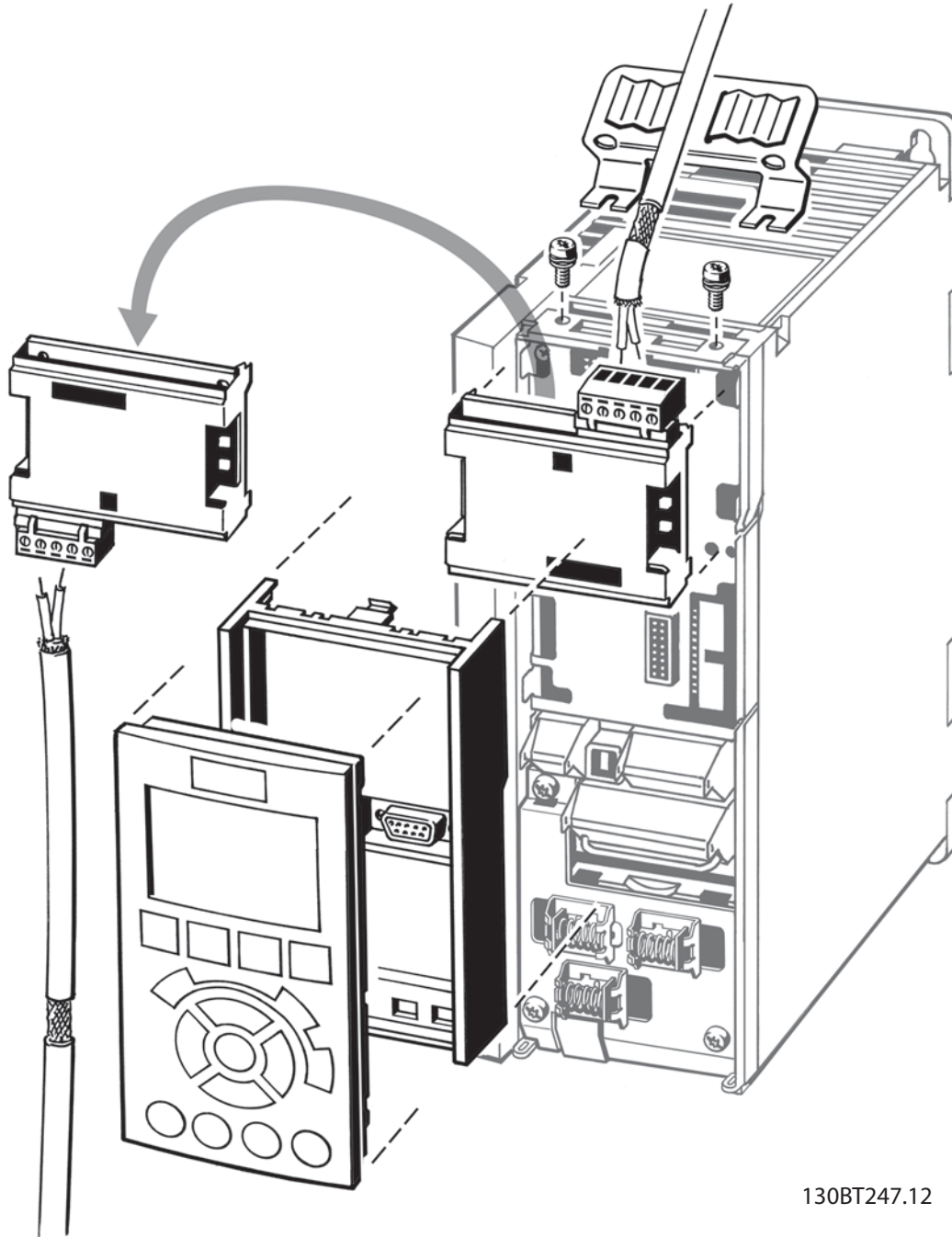
4

Instructions:

- Remove LCP panel from the IVS 102
- Remove the frame located beneath and discard
- Push the option into place. Two positions are possible, with cable terminal facing either up or down
- Push the fieldbus option adaptor frame for the IVS 102 into place
- Replace the LCP and attach cable
- On A1 and A2 enclosures with cable terminal facing up: Fasten the cable onto the de-coupling plate (the IVS 102 top surface has pre-drilled threaded holes for attaching the de-coupling plate to the unit).

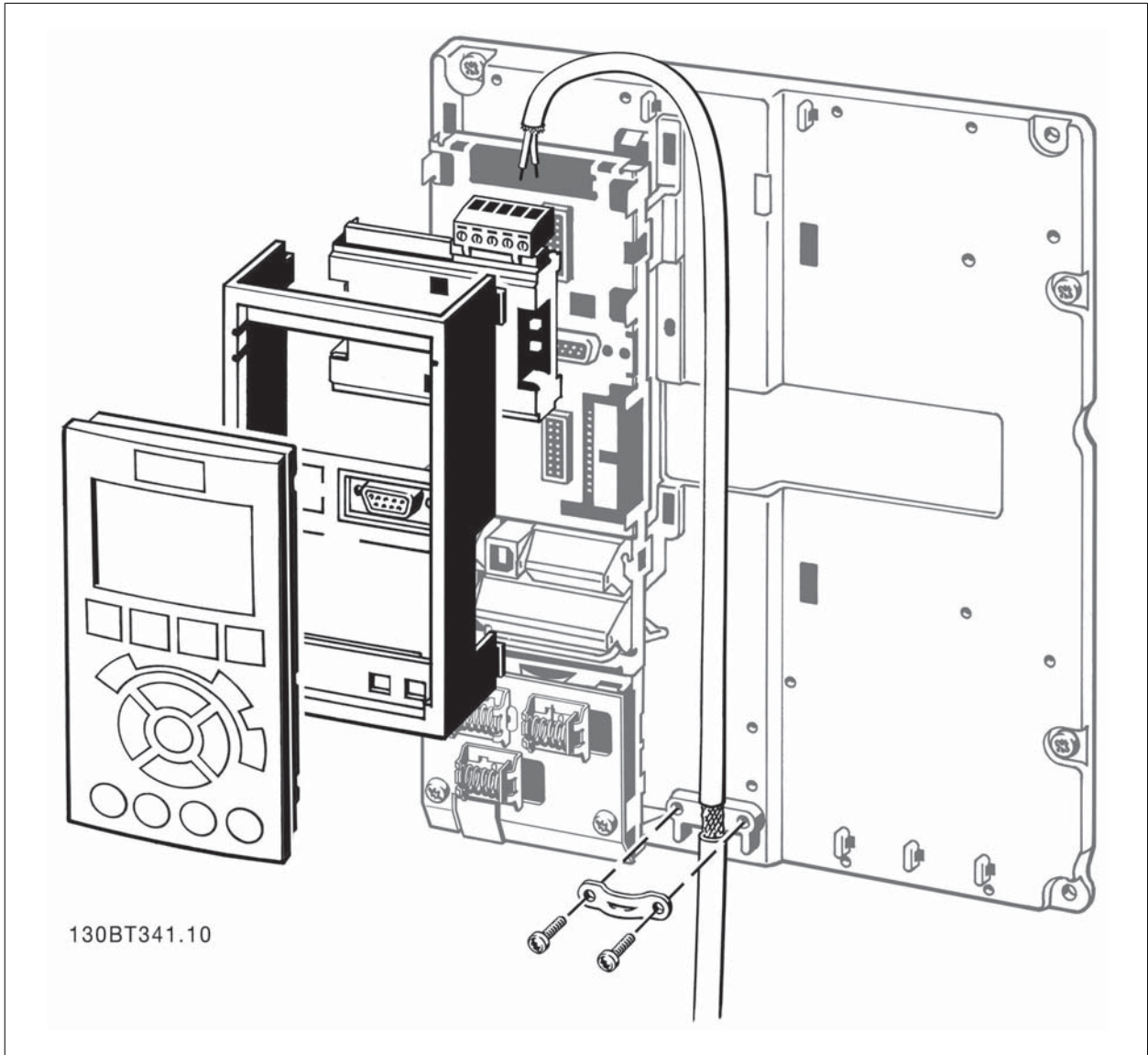

5 Configuration of the system

5.1 Configuring the System

5.1.1 How to Configure the LonWorks Network

The LonWorks option card contains a Neuron chip with a unique address. This Neuron ID is a 48 bit number that identifies each Neuron chip manufactured. Addressing nodes on the LonWorks network is performed at the time of installation using an installation tool or network management tool (e.g. LonMaker). Addressing requires the retrieval of the Neuron ID for the node.

There are several methods by which the network software can retrieve the Neuron ID and address the node:

1. Service Pin – The push-button service switch sends the Neuron ID over the network.
If the network software prompts the action, press the Service Pin switch (O400) to transmit the Neuron ID over the network. Please refer to the How to Install section for the location of the Service Pin switch.
2. Query and Wink - Upon receiving a Wink command, both LED's flashes (½ Hz for 20 sec.) so the installer can locate the node. The option sends out its Neuron ID over the network in response to the query command.
3. Neuron ID Label – The installer can manually enter the Neuron ID during installation. The Neuron ID can be found on the label of the option in text and barcode.

Resource Files

A LonMark interface file (.XIF file extension) provides the host processor with device information. Using this file it is possible to design a LonWorks network without the adjustable frequency converter being physically present. Other resource files are:

- Type file (.typ file extension)
- Format file (.fmt file extension)
- Language description file (.eng, .enu and other file extensions)

The resource files can be downloaded from the web site www.armstrongintegrated.com/BusinessAreas/DrivesSolution.

Here you will also find a free download of an LNS plug-in for the use in the LonMaker tool.

5.1.2 Functional Profiles

LonMark functional profiles are used to describe in detail the application layer interface, including the network variables, configuration properties, and commonly used control functions.

5.1.3 IVS VSD Profile

The IVS VSD Profile describes all Armstrong IVS specific network variables.

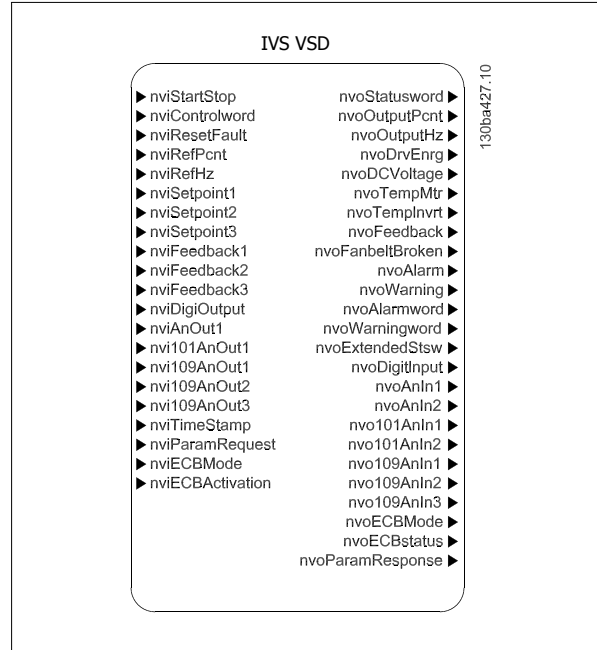

Input variables

Variable Function	Variable Name	SNVT type	Profile	IVS 102 par.
Start/Stop	nviStartStop	SNVT_switch	IVS VSD	CTW/reference
Control word	nviControlword	SNVT_state	IVS VSD	CTW
Reset fault	nviResetFaut	SNVT_switch	IVS VSD	CTW
Reference [%]	nviRefPcnt	SNVT_lev_percent	IVS VSD	Reference
Reference [Hz]	nviRefHz	SNVT_freq_hz	IVS VSD	Reference
CL Setpoint 1	nviSetpoint1	SNVT_lev_percent	IVS VSD	20-21
CL Setpoint 2	nviSetpoint2	SNVT_lev_percent	IVS VSD	20-22
CL Setpoint 3	nviSetpoint3	SNVT_lev_percent	IVS VSD	20-23
Bus feedback 1	nviFeedback1	SNVT_lev_percent	IVS VSD	8-94
Bus feedback 2	nviFeedback2	SNVT_lev_percent	IVS VSD	8-95
Bus feedback 3	nviFeedback3	SNVT_lev_percent	IVS VSD	8-96
Digital/relay outputs	nviDigiOutput	SNVT_state_64	IVS VSD	5-90
Analog output (42)	nviAnOut1	SNVT_lev_percent	IVS VSD	6-53
Analog output (X30/8)	nvi101AnOut1	SNVT_lev_percent	IVS VSD	6-63
Analog output (X42/7)	nvi109AnOut1	SNVT_lev_percent	IVS VSD	26-43
Analog output (X42/9)	nvi109AnOut2	SNVT_lev_percent	IVS VSD	26-53
Analog output (X42/11)	nvi109AnOut3	SNVT_lev_percent	IVS VSD	26-63
Setting of RTC	nviTimeStamp	SNVT_time_stamp	IVS VSD	0-70
ECB option Mode	nviECBMode	SNVT_state	IVS VSD	31-00
ECB By-pass activation	nviECBActivation	SNVT_switch	IVS VSD	31-19
Parameter access command	nviParamRequest	UNVT_param_request	IVS VSD	-

Output variables

Variable function	Variable name	SNVT type	Profile	IVS 102 par.
Status word	nvoStatusword	SNVT_state	IVS VSD	16-03
Drive output [%]	nvoOutputPcnt	SNVT_lev_percent	IVS VSD	16-05
Drive output [Hz]	nvoOutputHz	SNVT_freq_hz	IVS VSD	16-13
kWh counter	nvoDrvEnrg	SNVT_elec_kwh_l	IVS VSD	15-02
DC Link Voltage	nvoDCVoltage	SNVT_volt	IVS VSD	16-30
Motor thermal	nvoTempMtr	SNVT_lev_cont	IVS VSD	16-18
Inverter Thermal	nvoTempInvrtr	SNVT_lev_cont	IVS VSD	16-35
Closed loop feedback	nvoFeedback	SNVT_count_inc_f	IVS VSD	16-52
Fanbelt broken	nvoBrokenBelt	SNVT_switch	IVS VSD	16-93
Alarm flag	nvoAlarm	SNVT_switch	IVS VSD	16-90
Warning flag	nvoWarning	SNVT_switch	IVS VSD	16-03
Alarm word	nvoAlarmword	SNVT_state_64	IVS VSD	16-90 + 16-91
Warning word	nvoWarningword	SNVT_state_64	IVS VSD	16-92 + 16-93
Extended statusword	nvoExtendedStatusword	SNVT_state_64	IVS VSD	16-94 + 16-95
Digital inputs	nvoDigitInput	SNVT_state_64	IVS VSD	16-60
Analog Input (53)	nvoAnIn1	SNVT_volt/SNVT_amp_mil/SNVT_lev_percent	IVS VSD	16-62
Analog Input (54)	nvoAnIn2	SNVT_volt/SNVT_amp_mil/SNVT_lev_percent	IVS VSD	16-64
Analog Input (X30/11)	nvo101AnIn1	SNVT_volt/SNVT_lev_percent	IVS VSD	16-75
Analog Input (X30/12)	nvo101AnIn2	SNVT_volt/SNVT_lev_percent	IVS VSD	16-76
Analog Input (X42/1)	nvo109AnIn1	SNVT_volt/SNVT_temp_p/SNVT_lev_percent	IVS VSD	18-30
Analog Input (X42/3)	nvo109AnIn2	SNVT_volt/SNVT_temp_p/SNVT_lev_percent	IVS VSD	18-31
Analog Input (X42/5)	nvo109AnIn3	SNVT_volt/SNVT_temp_p/SNVT_lev_percent	IVS VSD	18-32
ECB option status	nvoECBstatus	SNVT_state	IVS VSD	31-10
Parameter access cmd.	nvoParamResponse	UNVT_param_response	IVS VSD	-

5.2 Network Variable Description

5.2.1 - IVS VSD Profile - input

Start/Stop

Variable name:	SNVT type:	State:	Value:	Command:
nviStartStop	SNVT_switch	0 (False)	Any	Stop (0x043C)
		1 (True)	0	Running 0% (0x047C)
		1 (True)	1-200	Running 0.5 to 100.0%
		1 (True)	201-255	Running100%
		0xFF (default)	Any	AUTO (invalid, no action)

This variable sends a Start or Stop command to the frequency converter and a reference (0 - 100 %)



NB!

The reference value of nviStartStop will only be valid if both nviRefPcnt and nviRefHz are = 0

Control Word

Variable name:	SNVT type:	State:
nviControlword	SNVT_state	Boolean 1 bit x 16

The input network variable nviControlWord is a 16-bit word providing additional operational control of the frequency converter. For more information about the Control word, please refer to the *Armstrong IVS Control Profile* section.



NB!

Please note in the representation of the Control Word in the LonMaker Browser, the LSB is to the far left.

Reset fault

Variable name:	SNVT type:	State:	Value:	Command:
nviResetFault	SNVT_switch	0 (False)	Any	No reset
		1 (True)	Any	Reset (0x04B)
		0xFF (default)	Any	AUTO (invalid, no action)

This variable sends a reset command to the frequency converter via bit 7 in the Control Word (0x04BC), see the *Armstrong IVS Control Profile* section.

Reference [%]

Variable name:	SNVT type:	Value:		
nviRefPcnt	SNVT_lev_percent	Min.	Max.	Resolution:
		-163.840 %	+163.830 %	0.005 %

This variable sends the speed reference to the frequency converter. It represents a percentage of the reference range of the frequency converter. In closed loop operation the reference is interpreted as the setpoint.

Reference [Hz]

Variable name:	SNVT type:	Value:		
nviRefHz	SNVT_freq_hz	Min.:	Max.:	Resolution:
		0.0 Hz	6,553.5 Hz	0.1 Hz

This variable sends the speed reference to the frequency converter in Hz, in open loop mode. In closed loop mode it is used as the Set-point.

Closed Loop Set-point 1-3

Variable name:	SNVT type:	Value:		
nviSetpoint1-3	SNVT_lev_percent	Min.:	Max.:	Resolution:
		-163.840 %	163.830 %	0.005 %

This variable sends up to 3 different set-points to the frequency converter via the bus.



NB!
Please refer to section *Reference Handling* for more information

Bus Feedback 1-3

Variable name:	SNVT type:	Value:		
nviFeedback1-3	SNVT_lev_percent	Min.:	Max.:	Resolution:
		-163.840 %	163.830 %	0.005 %

This variable sends up to 3 different feedback signals to the frequency converter via the bus.



NB!
For more information on how to manage multiple set-points and feedback sources, please refer to *IVS 102 Drive Programming Guide MG.11.BX.YY.*

Digital / Relay Outputs

Variable name:	SNVT type:	State:
nviDigitOutput	SNVT_state_64	Boolean 1 bit x 64

This variable controls the state of the digital outputs and relays.

A logical 1, indicates that the output is On or active.

A logical 0, indicates that the output is Off or inactive.

Bit 0	CC Digital Output Terminal 27
Bit 1	CC Digital Output Terminal 29
Bit 2	GPIO Digital Output Terminal X30/6
Bit 3	GPIO Digital Output Terminal X30/7
Bit 4	CC Relay 1 output terminal
Bit 5	CC Relay 2 output terminal
Bit 6	Option B Relay 1 output terminal
Bit 7	Option B Relay 2 output terminal
Bit 8	Option B Relay 3 output terminal
Bit 9-63	Reserved for future terminals

Analog Output (42)

Variable name:	SNVT type:	Value:
		Min.: Max.: Resolution:
nviAnOut1	SNVT_lev_percent	0 % 100 % 0.01 %

This variable controls the analog output 42, 0-20 mA or 4-20 mA.

In order to control output 42 via LonWorks, par. 6-50 *Terminal 42 Output* must be set to one of the following options:

- [139] Bus ctrl. 0-20 mA
- [140] Bus ctrl. 4-20 mA
- [141] Bus ctrl. 0-20 mA Timeout
- [142] Bus ctrl. 4-20 mA Timeout

Function:

Bus ctrl. 0-20 mA [139]: The output is controlled via bus. In the event of bus timeout, the output level remains unchanged.

Bus ctrl. 4-20 mA [140]: The output is controlled via bus. In the event of bus timeout, the output level remains unchanged.

Bus ctrl. 0-20 mA [141]: The output is controlled via bus. In the event of bus timeout, the output level is set to the predefined level in par. 6-54 *Terminal 42 Output Timeout Preset*.

Bus ctrl. 4-20 mA [142]: The output is controlled via bus. In the event of bus timeout, the output level is set to the predefined level in par. 6-54 *Terminal 42 Output Timeout Preset*.

Analog Output (X30 / 8)

Variable name:	SNVT type:	Value:		
		Min.:	Max.:	Resolution:
nvi101AnOut1	SNVT_lev_percent	0 %	100 %	0.01 %



NB!
This output variable applies only if the General Purpose I/O option is installed in the frequency converter.

This variable controls the X30/8 analog output on the General Purpose I/O option 0-20 mA or 4-20 mA.

In order to control output X30/8 via LonWorks, par. 6-60 *Terminal X30/8 Output* must be set to one of the following options:

[139] Bus ctrl. 0-20 mA

[140] Bus ctrl. 4-20 mA

[141] Bus ctrl. 0-20 mA Timeout

[142] Bus ctrl. 4-20 mA Timeout

Function:

Bus ctrl. 0-20 mA [139]: The output is controlled via bus. In the event of bus timeout, the output level remains unchanged.

Bus ctrl. 4-20 mA [140]: The output is controlled via bus. In the event of bus timeout, the output level remains unchanged.

Bus ctrl. 0-20 mA [141]: The output is controlled via bus. In the event of bus timeout, the output level is set to the predefined level in par. 6-64 *Terminal X30/8 Output Timeout Preset*.

Bus ctrl. 4-20 mA [142]: The output is controlled via bus. In the event of bus timeout, the output level is set to the predefined level in par. 6-64 *Terminal X30/8 Output Timeout Preset*.

Analog Output (X42 / 7)

Variable name:	SNVT type:	Value:		
		Min.:	Max.:	Resolution:
nvi109AnOut1	SNVT_lev_percent	0 %	100 %	0.01 %

Analog Output (X42 / 9)

Variable name:	SNVT type:	Value:		
		Min.:	Max.:	Resolution:
nvi109AnOut2	SNVT_lev_percent	0 %	100 %	0.01 %

Analog Output (X42 / 11)

Variable name:	SNVT type:	Value:		
		Min.:	Max.:	Resolution:
nvi109AnOut3	SNVT_lev_percent	0 %	100 %	0.01 %

These variables contain the value allocated to the analog output terminal X42/7-11 of the *Analog I/O option*. The variable type is changeable with the commissioning tool.



NB!
This variable is available only if the Analog I/O option (MCB 109) has been installed.

Setting of RTC

Variable name:	SNVT type:	Field:					
nviTimeStamp	SNVT_time_stamp	Year	Month	Day	Hour	Minute	Second
		2000 -3000	0 - 12	0 - 31	0 - 23	0 - 59	0 - 59

5

Use this input to set the built-in Real Time Clock.

ECB Option Mode

Variable name:	SNVT type:	State:
nviECBMode	SNVT_state	Boolean 1 bit x 16

Controls the operation mode of the ECB option. The binary value of this variable is mapped directly into par. 31-00 *Bypass Mode*.

- [0] Drive
- [1] Bypass

ECB Remote By-pass Activation

Variable name:	SNVT type:	State:
nviECBActivation	SNVT_state	Boolean 1 bit x 16

Controls the remote activation of the ECB option.
The binary value of this variable is mapped directly into par. 31-90.
[0] Disabled
[1] Enabled



NB!
This input variable applies only if the ECB option is installed in the frequency converter.

Parameter Access Command

Variable name:	SNVT type:	Value:
nviParamRequest	SNVT_param_request	

These input variables are used for for frequency converter parameter access.
For more information on parameter access, please refer to *How to Access IVS 102 Parameters* section.

5.2.2 Network variable description on - IVS VSD Profile - output

Status Word

Variable name:	SNVT type:	State:
nvoStatusWord	SNVT_state	Boolean 1 bit x 16

This variable is a 16-bit word providing status information on the frequency converter. For more information on the status word, please refer to the *Armstrong IVS Control Profile* section.



NB!
Please note that in the representation of the Status Word in the LonMaker Browser, the Least Significant Bit (LSB) is to the far left.

Drive Output [%]

Variable name:	SNVT type:	Value:		
nvoOutputPcnt	SNVT_lev_percent	Min.	Max.	Resolution:
		-163.840 %	+163.840 %	0.005 %

In open loop operation, this variable contains the frequency converter output frequency in percentage, within the reference range.
In closed loop operation, this variable contains the frequency converter feedback signal, within the reference range.

Drive Output [Hz]

Variable name:	SNVT type:	Value:		
nvoOutputHz	SNVT_freq_hz	Min.	Max.	Resolution:
		0 Hz	6,500 Hz	1 Hz

This variable displays the actual output of the frequency converter motor frequency in Hz.

kWh Counter [kWh]

Variable name:	SNVT type:	Value:		
nvoDrvEnrg	SNVT_elec_kwh_I	Min.	Max.	Resolution:
		0 kWh	219,748,364.8 kWh	1 kWh

This variable contains the power consumption of the motor in kWh measured as a mean value over a one hour period.

DC Link Voltage [V]

Variable name:	SNVT type:	Value:		
		Min.	Max.	Resolution:
nvoDCVoltage	SNVT_volt	0 V	10,000 V	0.1 V

This variable contains the measured Dc-link voltage. The value is filtered and therefore may be delayed with up to 1.3 seconds before a voltage change is reflected in the output variable.

Motor Thermal [%]

Variable name:	SNVT type:	Value:		
		Min.	Max.	Resolution:
nvoTempMrt	SNVT_lev_cont	0 %	100 %	0.5 %

This variable contains the calculated / estimated thermal load on the motor. The cut-out limit is at 100%.

Inverter Thermal [%]

Variable name:	SNVT type:	Value:		
		Min.	Max.	Resolution:
nvoTempInvtrr	SNVT_lev_cont	0 %	100 %	0.5 %

This variable contains the percentage thermal load of the inverters. The cut-out limit is at 100%.

Closed Loop Feedback

Variable name:	SNVT type:	Value:		
		Min.	Max.	Resolution:
nvoFeedback	SNVT_count_inc_f	0 %	100 %	0.5 %

This variable contains the summerized amount of network feedback in closed loop mode.

Fanbelt broken

Variable name:	SNVT type:	State:	Value:	Command:
nvoBrokenbelt	SNVT_switch	0 (False)	Any	Fanbelt not broken
		1 (True)	Any	Fanbelt broken

This variable indicates whether the fanbelt is intact or broken (indicated by bit 8 in Warning Word 2).

Alarm Flag

Variable name:	SNVT type:	State:	Value:	Command:
nvoAlarm	SNVT_switch	0 (False)	0	No alarm(s) present
		1 (True)	100	Alarm(s) present

This variable indicates whether any alarm is present.

Warning Flag

Variable name:	SNVT type:	State:	Value:	Command:
nvoWarning	SNVT_switch	0 (False)	0	No warning(s) present
		1 (True)	100	Warning(s) present

This variable indicates whether any warning is present.

Alarm Word

Variable name:	SNVT type:	State:
nvoAlarmword	SNVT_state_64	Boolean 1 bit x 64

This variable contains the complete alarm word.

For more detailed information on the Alarm Word, please refer to the *Troubleshooting* section of this manual.

NB!
Please note that in the representation of the Alarm Word in the LonMaker Browser, the Least Significant Bit (LSB) is to the far left.

Warning Word

Variable name:	SNVT type:	State:
nvoWarningword	SNVT_state_64	Boolean 1 bit x 64

This variable contains the complete warning word.

For more detailed information on the Warning Word, please refer to the *Troubleshooting* section of this manual.

NB!
Please note that in the representation of the Warning Word in the LonMaker Browser, the Least Significant Bit (LSB) is to the far left.

Extended Status Word

Variable name:	SNVT type:	State:
nvoExtendedStatusword	SNVT_state_64	Boolean 1 bit x 64

This variable contains the complete extended status word.
 For more detailed information on the Extended Status Word, please refer to the *Troubleshooting* section of this manual.



NB!
 Please note that in the representation of the Extended Status Word in the LonMaker Browser, the Least Significant Bit (LSB) is to the far left.

5

Digital Inputs

Variable name:	SNVT type:	State:
nvoDigitInput	SNVT_state_64	Boolean 1 bit x 64

This variable contains the status of the digital inputs.
 A logical 1, indicates that the input is On or active.
 A logical 0, indicates that the input is Off or inactive.

Bit 0	Digital Input Terminal 33
Bit 1	Digital Input Terminal 32
Bit 2	Digital Input Terminal 29
Bit 3	Digital Input Terminal 27
Bit 4	Digital Input Terminal 19
Bit 5	Digital Input Terminal 18
Bit 6	Reserved for future terminals
Bit 7	Digital Input GP I/O Terminal X30/2
Bit 8	Digital Input GP I/O Terminal X30/3
Bit 9	Digital Input GP I/O Terminal X30/4
Bit 10-63	Reserved for future terminals

Analog Input (53)

Variable name:	SNVT type:	Value:		
		Min.	Max.	Resolution:
nvoAnIn1	Changeable			
	SNVT_volt	0 V	10 V	0.1 V
	SNVT_amp_mil	0 mA	20 mA	0.1 mA
	SNVT_lev_percent	0 %	100 %	0,1 %

This variable contains the value allocated to the analog input terminal 53.
 This terminal can either be configured as a voltage input (0-10 V) or as a current input (0-20 mA), depending on the setting of switch S 201. The variable type is changeable with the commissioning tool or LNS Plug-in in order to match the appropriate unit.

If the variable type of SNVT_lev_percent is selected, the relative scaling is from 0 V/mA to par. 6-11 *Terminal 53 High Voltage* or par. 6-13 *Terminal 53 High Current*

Analog Input (54)

Variable name:	SNVT type:	Value:		
nvoAnIn1	Changeable	Min.	Max.	Resolution:
	SNVT_volt	0 V	10 V	0.1 V
	SNVT_amp_mil	0 mA	20 mA	0.1 mA
	SNVT_lev_percent	0 %	100 %	0,1 %

This variable contains the value allocated to the analog input terminal 54.

This terminal can either be configured as a voltage input (0-10 V) or as a current input (0-20 mA), depending on the setting of switch S 202. The variable type is changeable with the commissioning tool in order to match the appropriate unit.

If the variable type of SNVT_lev_percent is selected, the relative scaling is from 0 V/mA to par. 6-21 *Terminal 54 High Voltage* or par. 6-23 *Terminal 54 High Current*

Analog Input (X30/11)

Variable name:	SNVT type:	Value:		
nvo101AnIn1	Changeable	Min.	Max.	Resolution:
	SNVT_volt	0 V	10 V	0.1 V
	SNVT_lev_percent	0 %	100 %	0,1 %

This variable contains the value allocated to the analog input terminal X30/11 of the *General Purpose I/O option, MCB101*.

If the variable type of SNVT_lev_percent is selected, the relative scaling is from 0 V to par. 6-31 *Terminal X30/11 High Voltage*.



NB!
This variable is available only if the General Purpose I/O option (MCB101) has been installed.

Analog Input (X30/12)

Variable name:	SNVT type:	Value:		
nvo101AnIn2	Changeable	Min.	Max.	Resolution:
	SNVT_volt	0 V	10 V	0.1 V
	SNVT_lev_percent	0 %	100 %	0,1 %

This variable contains the value allocated to the analog input terminal X30/12 of the *General Purpose I/O option, MCB101*.

If the variable type of SNVT_lev_percent is selected, the relative scaling is from 0 V to par. 6-41 *Terminal X30/12 High Voltage*.



NB!
This variable is available only if the General Purpose I/O option (MCB101) has been installed.

Analog Input (X42/1)

Variable name:	SNVT type:	Value:		
		Min.	Max.	Resolution:
nvo109AnIn1	Changeable			
	SNVT_volt	0 V	10 V	0.1 V
	SNVT_temp_p	-273.15 °C	327.66 °C	0.01 °C
	SNVT_lev_percent	0 %	100 %	0,1 %

Analog Input (X42/3)

Variable name:	SNVT type:	Value:		
		Min.	Max.	Resolution:
nvo109AnIn2	Changeable			
	SNVT_volt	0 V	10 V	0.1 V
	SNVT_temp_p	-273.15 °C	327.66 °C	0.01 °C
	SNVT_lev_percent	0 %	100 %	0,1 %

Analog Input (X42/5)

Variable name:	SNVT type:	Value:		
		Min.	Max.	Resolution:
nvo109AnIn3	Changeable			
	SNVT_volt	0 V	10 V	0.1 V
	SNVT_temp_p	-273.15 °C	327.66 °C	0.01 °C
	SNVT_lev_percent	0 %	100 %	0,1 %

These variables contain the value allocated to the analog input terminal X42/1-5 of the *Analog I/O option, MCB109*. The variable type is changeable with the commissioning tool.

**NB!**

This variable is available only if the Analog I/O option (MCB109) has been installed.

ECB Option Status

Variable name:	SNVT type:	State:
nvoECBStatus	SNVT_state	Boolean 1 bit x 16

This variable displays the current status of the ECB option.

Bit 0	Test Mode
Bit 1	Drive Mode
Bit 2	Automatic By-pass Mode
Bit 3	By-pass Mode
Bit 4	Reserved
Bit 5	Motor Running from By-pass/Drive
Bit 6	Overload Trip
Bit 7	M2 Contactor Fault
Bit 8	M3 Contactor Fault
Bit 9	External Interlock
Bit 10	Manual By-pass Override



NB!

These variables are available only if the *Electronic Control By-pass option* (ECB) has been installed.

Parameter Access Response

Variable name:	SNVT type:
nvoParamResponse	UNVT_param_response

This output variable is used for the frequency converter access.

A special UNVT has been defined for this variable.

For more information on parameter access, please refer to the *How to Access IVS 102 Parameters* section.

5.3 VSD 6010 Profile

5.3.1 Introduction

The *Variable Speed Drive 6010* profile is a LonMark standardized functional profile.

It describes how to control a variable speed frequency converter.

For example, an air handling unit controller that sends messages to facilitate control of the start/stop and speed reference of the VSD. The VSD will deliver messages such as the actual frequency converter speed and output current to the controller, operating interfaces and energy management systems.

5

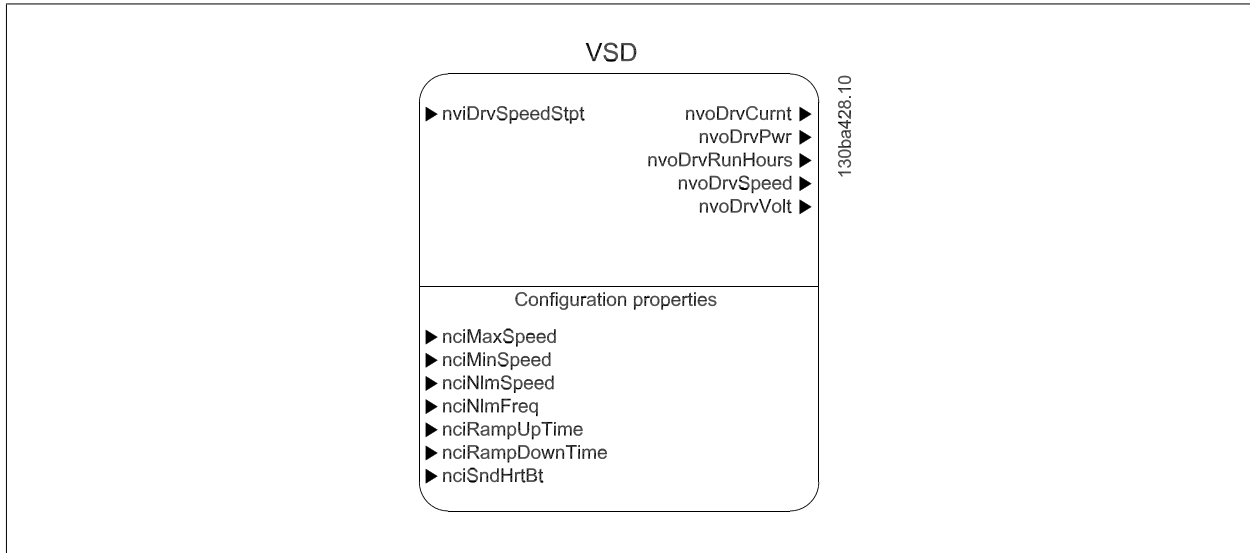

5.3.2 Input Variables

Variable function	Variable name	SNVT type	Profile	IVS 102 parameter
Drive speed setpoint	nviDrvSpeedStpt	SNVT_switch	VSD 6010	CTW / Reference

5.3.3 Output Variables

Variable function	Variable name	SNVT type	Profile	IVS 102 parameter
Drive speed	nvoDrvSpeed	SNVT_lev_percent	VSD 6010	16-05
Output current	nvoDrvCurnt	SNVT_amp	VSD 6010	16-14
Output voltage	nvoDrvVolt	SNVT_volt	VSD 6010	16-12
Output power	nvoDrvPwr	SNVT_power_kilo	VSD 6010	16-10
Running hours	nvoDrvRunHours	SNVT_time_hour	VSD 6010	15-01

5.3.4 Configuration Properties (nci)

Variable function	Variable name	SNVT type	Profile	IVS 102 parameter
Max. motor speed [%]	nciMaxSpeed	SNVT_lev_percent	VSD 6010	4-13
Min. motor speed [%]	nciMinSpeed	SNVT_lev_percent	VSD 6010	4-11
Nom. motor speed [RPM]	nciNmlSpeed	SNVT_rpm	VSD 6010	1-25
Nom. motor frequency [Hz]	nciNmlFreq	SNVT_freq_hz	VSD 6010	1-23
Min. ramp-up time [s]	nciRampUpTime	SNVT_time_sec	VSD 6010	3-41
Min. ramp-down time [s]	nciRampDownTime	SNVT_time_sec	VSD 6010	3-42
Heartbeat time [s]	nciSndHrtBt	SNVT_time_sec	VSD 6010	-

A range of network configuration variables (SCPT's) is available for configuration of the frequency converter parameters. These parameters require setting only once, usually following installation.



NB!
Please note that the settings written to configuration properties (nci's) will be stored in the non-volatile memory. Continuous writing to configuration properties may damage the non-volatile memory.

5.4 Network Variable Description - VSD Profile - input

5.4.1 Frequency Converter Speed Setpoint

Variable name:	SNVT type:	State:	Value:	Command:
nviDrvSpeedStpt	SNVT_switch	0 (False)	Any	Stop
		1 (True)	0	Running 0 %
		1 (True)	1-200	Running 0.5 to 100 %
		1 (True)	201-255	Running 100 %
		0xFF (default)	Any	AUTO (invalid, no action)

This input variable provides start / stop control and a speed reference.

5.5 Network Variable Description - VSD Profile - Output

5.5.1 Drive Speed

Variable name:	SNVT type:	Value:		
		Min:	Max:	Resolution:
nvoDrvSpeed	SNVT_lev_percent	-163.840 %	+163.830 %	0.005 %

This variable contains the frequency converter speed as a percentage of the nominal speed.

5

5.5.2 Output Current

Variable name:	SNVT type:	Value:		
		Min:	Max:	Resolution:
nvoDrvCurrt	SNVT_amp	0 A	3,276.6 A	0.1 A

This variable contains the frequency converter output current in ampere measured as a mean value, IRMS.

The value is filtered and therefore approximately 1.3 seconds delayed before a current change is reflected in the output variable.

5.5.3 Output Voltage

Variable name:	SNVT type:	Value:		
		Min:	Max:	Resolution:
nvoDrvVolt	SNVT_volt	0 V	3,276.6 V	0.1 V

This variable contains the frequency converter output voltage.

5.5.4 Output Power

Variable name:	SNVT type:	Value:		
		Min:	Max:	Resolution:
nvoDrvPwr	SNVT_power_kilo	0 kW	6,554.4 kW	0.1 kW

This variable contains the frequency converter output power in kW, calculated on the basis of the actual motor voltage and current.

The value is filtered and therefore approximately 1.3 seconds delayed before a power change is reflected in the output variable.

5.5.5 Running Hours

Variable name:	SNVT type:	Value:		
		Min:	Max:	Resolution:
nvoDrvRunHours	SNVT_time_hour	0 hr	65,534 hr	1 hr

This variable contains the total running hours of the motor.

5.6 Network Variable Descriptio n - VSD Profile - Configuration

5.6.1 Max Motor Speed [%]

Variable name:	SNVT type:	Default value:	Min value:	Max value:
nciMaxSpeed	SNVT_lev_percent	100 %	0 %	163.830 %

This variable configures the maximum motor speed in % and associates it with par. 4-13 *Motor Speed High Limit [RPM]* (par. 4-14 in Hz mode). The value is entered as a percent of nominal speed, as defined by the Nominal Speed (nciNmSpeed) configuration value. For more information on reference scaling, please refer to the *How to Control the IVS 102* section. If a value higher than 163.830% is requested, use the parameter access command.

5.6.2 Min Motor Speed [%]

Variable name:	SNVT type:	Default value:	Min value:	Max value:
nciMinSpeed	SNVT_lev_percent	0 %	0 %	163.830 %

This variable configures the minimum motor speed in % and associates it with par. 4-11 *Motor Speed Low Limit [RPM]* (par. 4-12 in Hz mode). The value is entered as a percent of nominal speed, as defined by the Nominal Speed (nciNmSpeed) configuration value. For more information on reference scaling, please refer to the *How to Control the IVS 102* section.

5.6.3 Nom Motor Speed [RPM]

Variable name:	SNVT type:	Default value:	Min value:	Max value:
nciNmSpeed	SNVT_rpm	1420 RPM	10 RPM	65,534 RPM

This variable configures the nominal motor speed in RPM and associates it with par. 1-25 *Motor Nominal Speed*.



NB!
Please note that this variable can be adjusted only while the frequency converter is stopped.
If a value lower than 10 RPM is entered, nciNmSpeed will be set to 10 RPM.

5.6.4 Nominal Motor Frequency [Hz]

Variable name:	SNVT type:	Default value:	Min value:	Max value:
nciNmFreq	SNVT_freq_hz	50 Hz	20 Hz	100 Hz

This variable configures the nominal motor frequency and associates it with par. 1-23 *Motor Frequency*.



NB!
Please note that this variable can be adjusted only while the frequency converter is stopped.
If a value lower than 20 Hz is entered, nciNmFreq will be set to 20 Hz.

5.6.5 Min Ramp-up Time [s]

Variable name:	SNVT type:	Default value:	Min value:	Max value:
nciRampUpTime	SNVT_time_sec	10 s	1 s	3,600 s

This variable configures the Ramp 1 ramp-up time and associates it with par. 3-41 *Ramp 1 Ramp Up Time*.

5.6.6 Min Ramp-down Time [s]

Variable name:	SNVT type:	Default value:	Min value:	Max value:
nciRampDownTime	SNVT_time_sec	10 s	1 s	3,600 s

This variable configures the Ramp 1 ramp-down time and compares it with par. 3-42 *Ramp 1 Ramp Down Time*.

5.6.7 Heartbeat Time [s]

Variable name:	SNVT type:	Default value:	Min value:	Max value:
nciSndHrtBt	SNVT_time_sec	0 s	0 s	6,553.4 s

This variable configures a heartbeat timer to send the following variables:

- nvoDrvCurnt
- nvoDrvSpeed
- nvoDrvVolt
- nvoDrvPwr

Setting the timer to 0.0 disables the timer.

Heartbeat timers have the purpose of sending out heartbeat signals containing specific data, enabling management systems to prove that the node is present on the network and working correctly. Only bound variables will be transmitted.

5.7 Node Object

5.7.1 Node Object

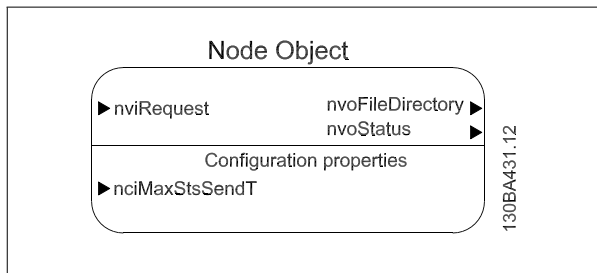

These variables are used for controlling all functional blocks via the commissioning tool.

5.7.2 Object Request

Variable name:	SNVT type:	Supported functions:	Description:
nviRequest	SNVT_obj_request	RQ_Normal	Returns the specified functional block to normal operation.
		RQ_Update_Status	Requests the status of the specified functional block.
		RQ_Report_Mask	Requests a status mask reporting the status bits that are supported by the specified functional block.
		RQ_Disabled	Requests the specified functional block to change to the disabled state. In the disabled state, output network variables belonging to the functional block are not propagated within the network.
		RQ_Enable	Requests the specified functional block to change to the enabled state. In the enabled state, output network variables belonging to the functional block are propagated within the network as defined by the functional block.

5.7.3 Object Response

Variable name:	SNVT type:	Description:
nvoStatus	SNVT_object_status	This output network variable reports the status for any functional block on a device. It is also used to report the status of the entire device and all functional blocks on the device.

5.7.4 Max. Send Time (Heartbeat)

Variable name:	SNVT type:	Default value:	Min value:	Max value:
nciMaxStsSendT	SNVT_elapsed_tm	00:0:0:0	00:0:0:0	017:59:59:999

This variable configures a timer to send the nvoStatus object but only if bound to an input variable. Maximum is '0 17:59:59:999' (0 days, 17 hours, 59 minutes, 59 seconds and 999 milliseconds). Setting the timer to '0 0:0:0:0' disables it.

Network timer functions monitor node presence and control behaviour in the event of network problems occurring.

5.8 Network Timer Functions

5.8.1 Control Word Time-out Function

par.8-03 *Control Timeout Time* and par.8-04 *Control Timeout Function* provide a means for the frequency converter to control communication to a controller node.

If a valid control word has not been received within the time specified in par. 8-03, the action specified in par. 8-04 will be performed. The default action is OFF (no action).

The range of par. 8-03 is: 0.1 to 18,000 seconds (or 5 hours).

An update of the control word is triggered by the following SNVT's:

- nviStartStop
- nviResetFault
- nviControlword
- nviDrvSpeedStpt
- nviRefPcnt
- nviRefHz
- nviFeedback 1,2,3
- nviSetPoint 1,2,3

5

5.8.2 Min. Send Time (Inhibit Timer)

Variable name:	SNVT type:	Default value:	Min value:	Max value:
nciMinSendT	SNVT_elapsed_tm	00:0:0:500	0 0:0:0:100	0 0:01:05:535

Variable used for limiting bus traffic by setting a minimum sending timer (inhibit timer).

Applies for all output variables.

Format: Days Hours:Minutes:Seconds:Milliseconds.

6 How to control the Frequency Converter

6.1 How to Control the IVS 102

6.1.1 Reference Handling

Select the frequency converter configuration mode in par. 1-00 *Configuration Mode*.

- [0] Open Loop
- [3] Closed Loop

6.1.2 Open Loop

For open loop operation, the reference represents the desired output speed of the frequency converter.
The speed reference value is transmitted to the frequency converter as a relative value in %.

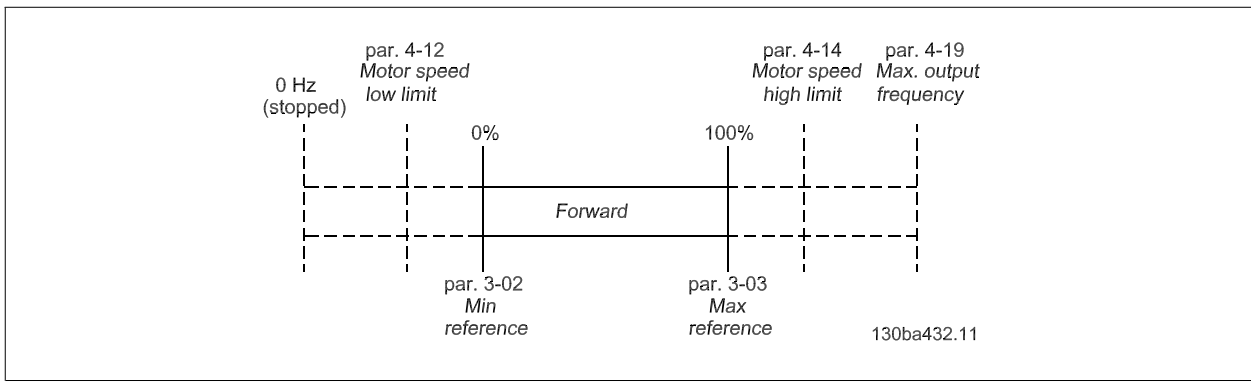

6.1.3 Closed Loop

In closed loop operation the feedback/reference is scaled from 1 to par. 20-14 *Maximum Reference/Feedb.*

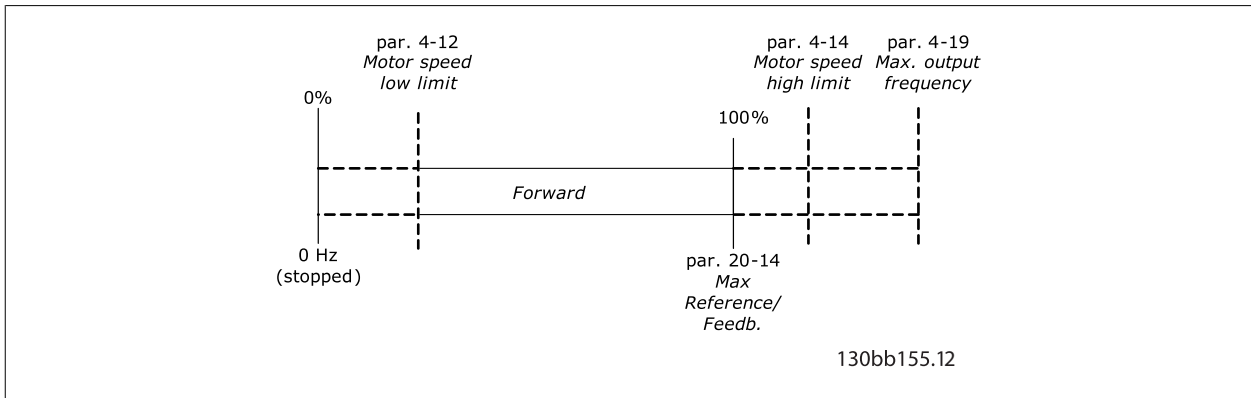

NB!
 Please refer to the *Troubleshooting* section to see an example of reference scaling.
 All references provided to the frequency converter are added to the total reference value.
 If a reference is to be controlled by the LonWorks bus only, please ensure that all other reference inputs are zero.
 This means that digital and analog input terminals should not be used for reference signals.
 The default setting (0%) should be maintained for preset references in par. 3-10 *Preset Reference*

6 How to control the Frequency Converter

6.2 Armstrong IVS Control Profile

6.2.1 IVS Control Profile

Control Word According to IVS Profile

(Par. 8-10 set to *IVS Profile*)

Bit	Bit value=0	Bit value=1
00	Reference value	External selection lsb
01	Reference value	External selection msb
02	DC brake	Ramp
03	Coasting	No coasting
04	Quick stop	Ramp
05	Hold output freq.	Use ramp
06	Ramp stop	Start
07	No function	Reset
08	No function	Jog
09	Ramp 1	Ramp 2
10	Data invalid	Data valid
11	No function	Relay 01 active
12	No function	Relay 04 active
13	Parameter set-up	Selection lsb
14	Parameter set-up	Selection msb
15	No function	Reverse

6

6.2.2 Explanation of the Control Bits

Bits 00 and 01:

Bits 00 and 01 are used to choose between the four reference values, which are pre-programmed in par. 3-10 *Preset Reference* in accordance with the following table:

Programmed ref. value	Parameter	Bit 01	Bit 00
1	3-10 [0]	0	0
2	3-10 [1]	0	1
3	3-10 [2]	1	0
4	3-10 [3]	1	1



NB!

In par.8-56 *Preset Reference Select*, a selection is made to define how Bit 00/01 gates with the corresponding function on the digital inputs.

Bit 02, DC brake:

Bit 02 set to [0] leads to DC braking and stop of the motor. Braking current and duration are set in par. 2-01 *DC Brake Current* and par. 2-02 *DC Braking Time*.

Bit 02 set to [1] leads to ramping.

Bit 03, Coasting:

Bit 03 set to [0] causes the frequency converter to immediately release of the motor (the output transistors are "shut off"), so that it coasts to a standstill.

Bit 03 set to [1] enables the frequency converter to start the motor if other starting conditions have been fulfilled.



NB!

In par.8-50 *Coasting Select*, a selection is made to define how Bit 03 gates with the corresponding function on a digital input.

Bit 04, Quick Stop:

Bit 04 set to [0] causes a stop in which the motor speed is ramped down to stop via par. 3-81 *Quick Stop Ramp Time*.

Bit 05, Hold output frequency:

Bit 05 set to [0] causes the present output frequency (Hz) to freeze. The frozen output frequency can then be changed only by means of the digital inputs set by par. 5-10 to 5-15, programmed to [Speed up] or [Speed down].



NB!

If [Freeze output] is active, the frequency converter can only be stopped by the following:

- Bit 03 Coasting stop
- Bit 02 DC braking
- Digital input (par. 5-10 to 5-15) programmed to DC braking, Coasting stop or Reset and coasting stop.

Bit 06, Ramp stop/start:

Bit 06 set to [0] causes a stop, in which the motor speed is ramped down to stop via the selected ramp down parameter.

Bit 06 set to [1] permits the frequency converter to start the motor, if other starting conditions have been fulfilled.



NB!
In par.8-53 *Start Select*, a selection is made to define how Bit 06 Ramp stop/start gates with the corresponding function on a digital input.

Bit 07, Reset:

Bit 07 set to [0] means no reset.

Bit 07 set to [1] resets a trip. Reset is activated on the leading edge of the signal, i.e. when changing from logic '0' to logic '1'.

Bit 08, Jog:

Bit 08 set to [1] causes the output frequency to be determined by par. 3-19 *Jog Speed [RPM]*.

Bit 09, Selection of ramp:

Bit 09 set to [0] means that ramp 1 is active (par. 3-40 to 3-47).

Bit 09 set to [1] means that ramp 2 (par. 3-50 to 3-57) is active.

Bit 10, Data not valid / Data valid:

This bit tells the frequency converter whether the control word is to be used or ignored. Bit 10 set to [0] causes the control word to be ignored.

Bit 10 set to [1] causes the control word to be used.

The control word is always contained in the telegram, regardless of which type of telegram is used, so this function is useful for 'turning off' the control word when not required for updating or for reading parameters.

Bit 11, Relay 01:

Bit 11 set to [0] means that Relay is not activated.

Bit 11 set to [1] activates Relay 01, provided *Control word bit 11* [36] has been chosen in par. 5-40 *Function Relay*.

Bit 12, Relay 04:

Bit 12 set to [0] means that Relay 04 has not been activated.

Bit 12 set to [1] activates Relay 04, provided *Control word bit 12* [37] has been chosen in par. 5-40 *Function Relay*.

Bit 13 and 14, Selection of set-up:

Bits 13 and 14 are used to select one of four menu set-ups according to the following table:

Set-up	Bit 14	Bit 13
1	0	0
2	0	1
3	1	0
4	1	1

The function is only possible when Multi-Set-up [9] is selected in par. 0-10 *Active Set-up*.



NB!
In par.8-55 *Set-up Select*, a selection is made to define how Bit 13/14 gates with the corresponding function on the digital inputs.

Bit 15, Reverse:

Bit 15 set to [0] causes no reversing.

Bit 15 set to [1] causes reversing.

Note: par. 4-10 *Motor Speed Direction* determines if reversing is possible.

6.2.3 Status Word According to IVS Profile (STW)

Parameter 8-10 set to [IVS profile]

Bit	Bit value=0	Bit value=1
00	Control not ready	Control ready
01	Drive not ready	Drive ready
02	Coasting	Enable
03	No error	Trip
04	No error	Error (no trip)
05	Reserved	-
06	No error	Trip lock
07	No warning	Warning
08	Speed # reference	Speed = reference
09	Local operation	Bus control
10	Out of frequency limit	Frequency limit ok
11	No operation	In operation
12	Brake ok	Brake warning or failure
13	Voltage ok	Voltage exceeded
14	Torque ok	Torque exceeded
15	Timer ok	Timer exceeded

6 How to control the Frequency Converter

6.2.4 Explanation of the Status Bits

Bit 00, Control not ready / ready:

Bit 00 set to [0] means that the frequency converter has tripped.

Bit 00 set to [1] means that the frequency converter controls are ready, but that the power component is not necessarily receiving any power supply (in the event of external 24 V supply to controls).

Bit 01, Drive ready:

Bit 01 set to [1] means that the frequency converter is ready for operation, but it is receiving an active coasting command via the digital inputs or via serial communication.

Bit 02, Coasting stop:

Bit 02 set to [0] means that the frequency converter has released the motor.

Bit 02 set to [1] means that the frequency converter can start the motor when a start command is given.

Bit 03, No error / trip:

Bit 03 set to [0] means that the frequency converter is not in fault mode.

Bit 03 set to [1] means that the frequency converter is tripped and that a reset signal is required to re-establish operation.

Bit 04, No error / error (no trip):

Bit 04 set to [0] means that the frequency converter is not in fault mode.

Bit 04 set to [1] means that there is a frequency converter error but no trip.

Bit 05, Not used:

Bit 05 is not used in the status word.

Bit 06, No error / trip lock:

Bit 06 set to [0] means that the frequency converter is not in fault mode.

Bit 06 set to [1] means that the frequency converter is tripped and locked.

Bit 07, No warning / warning:

Bit 07 set to [0] means that there are no warnings.

Bit 07 set to [1] means that a warning has occurred.

Bit 08, Speed # reference / speed = reference:

Bit 08 set to [0] means that the motor is running, but that the present speed is different from the preset speed reference. For example, this might occur while the speed is being ramped up/down during start/stop.

Bit 08 set to [1] means that the present motor speed matches the preset speed reference.

Bit 09, Local operation / bus control:

Bit 09 set to [0] means that [STOP/RESET] is activated on the control unit or that Local [2] control in par. 3-13 *Reference Site* is selected. It is not possible to control the frequency converter via serial communication.

Bit 09 set to [1] means that it is possible to control the frequency converter via the fieldbus / serial communication interface.

Bit 10, Out of frequency limit:

Bit 10 set to [0] enables the output frequency to reach the value in par. 4-11 *Motor Speed Low Limit [RPM]* or par. 4-13 *Motor Speed High Limit [RPM]*.

Bit 10 set to [1] means that the output frequency is within the defined limits.

Bit 11, No operation / in operation:

Bit 11 set to [0] means that the motor is not running.

Bit 11 set to [1] means that the frequency converter has received a start signal or that the output frequency is greater than 0 Hz.

Bit 12, Brake OK / Brake warning or failure:

Bit 12 = [0] means that there is no brake warning or failure present.

Bit 12 = [1] means that the drive has stopped because of a brake warning or failure.

Bit 13, Voltage OK / limit exceeded:

Bit 13 set to [0] means that there are no voltage warnings.

Bit 13 set to [1] means that the DC voltage in the frequency converter's intermediate circuit is too low or too high.

Bit 14, Torque OK / limit exceeded:

Bit 14 set to [0] means that the motor current is lower than the torque limit selected in par. 4-18 *Current Limit*.

Bit 14 set to [1] means that the torque limit in par. 4-18 *Current Limit* has been exceeded.

Bit 15, Timer OK / limit exceeded:

Bit 15 = [0] means that the timers for motor thermal protection and IVS thermal protection, respectively, have not exceeded 100%.

Bit 15 = [1] means that one of the timers has exceeded 100%.

7 How to access IVS 102 parameters

7.1 User-defined Network Variables UNVT

7.1.1 UNVT Parameter structure

Two special User-defined Network Variables (UNVT) have been defined to enable access to IVS 102 parameters via LonWorks:

Variable name:	UNVT type:
nviParamRequest	UNVT_param_request
nvoParamResponse	UNVT_param_response

The parameter- or attribute request has the following structure:

UNVT_param_request			
Field	Range	Type	Size
Request	1 = Read value 2 = Write value	Enum	1 byte
Par_number	Parameter number	Unsigned long	2 bytes
Subindex	Subindex (0-255)	Unsigned	1 byte
Value	Parameter value	Unsigned quad	4 bytes

The parameter- or attribute response has the following structure:

UNVT_param_response			
Field	Range	Type	Size
Response	0 = Error response 1 = Read response 2 = Write response	Enum	1 byte
Par_number	Parameter number	Unsigned long	2 bytes
Length	Length of "value" field (0-27)	Unsigned	1 byte
Value	Parameter or parameter attribute value	Unsigned	0-27 bytes

If an incorrect Read or Write request is encountered, an error message will be returned in the [Value] field, byte 0 and byte 3.

Error description:	Error code in Value [0]:	Error code in Value [3]:
Invalid request type	0xFF	1
Invalid parameter number	0xFF	2
Invalid data type	0xFF	3
No write access	0xFF	4
Exceed limits	0xFF	5
Invalid subindex	0xFF	6
Not array	0xFF	7
Only reset	0xFF	8
Not changeable	0xFF	9
Not in this mode	0xFF	10
No bus access	0xFF	11
Other error	0xFF	0xFE



7 How to access IVS 102 parameters

7.1.2 UNVT examples

Example: Read parameter 3-41

Ramp 1 Ramp-up Time

In the LonMaker browser, select the nviParamRequest and choose [Details].

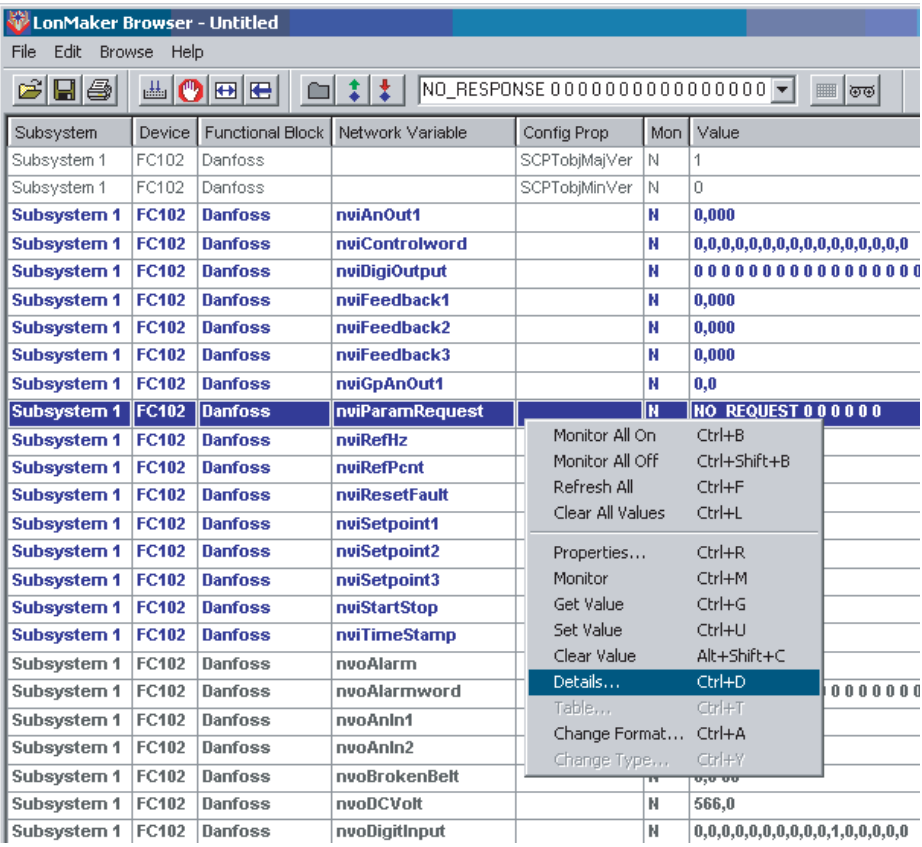

Subsystem	Device	Functional Block	Network Variable	Config Prop	Mon	Value
Subsystem 1	FC102	Danfoss		SCPTobjMajVer	N	1
Subsystem 1	FC102	Danfoss		SCPTobjMinVer	N	0
Subsystem 1	FC102	Danfoss	nviAnOut1		N	0,000
Subsystem 1	FC102	Danfoss	nviControlword		N	0,0,0,0,0,0,0,0,0,0,0,0,0,0,0
Subsystem 1	FC102	Danfoss	nviDigiOutput		N	0 0 0 0 0 0 0 0 0 0 0 0 0 0 0 0
Subsystem 1	FC102	Danfoss	nviFeedback1		N	0,000
Subsystem 1	FC102	Danfoss	nviFeedback2		N	0,000
Subsystem 1	FC102	Danfoss	nviFeedback3		N	0,000
Subsystem 1	FC102	Danfoss	nviGpAnOut1		N	0,0
Subsystem 1	FC102	Danfoss	nviParamRequest		N	NO REQUEST 0 0 0 0 0 0
Subsystem 1	FC102	Danfoss	nviReflz			
Subsystem 1	FC102	Danfoss	nviRefPcnt			
Subsystem 1	FC102	Danfoss	nviResetFault			
Subsystem 1	FC102	Danfoss	nviSetpoint1			
Subsystem 1	FC102	Danfoss	nviSetpoint2			
Subsystem 1	FC102	Danfoss	nviSetpoint3			
Subsystem 1	FC102	Danfoss	nviStartStop			
Subsystem 1	FC102	Danfoss	nviTimeStamp			
Subsystem 1	FC102	Danfoss	nvoAlarm			
Subsystem 1	FC102	Danfoss	nvoAlarmword			0 0 0 0 0 0 0 0
Subsystem 1	FC102	Danfoss	nvoAnIn1			
Subsystem 1	FC102	Danfoss	nvoAnIn2			
Subsystem 1	FC102	Danfoss	nvoBrokenBelt			
Subsystem 1	FC102	Danfoss	nvoDCVolt		N	566,0
Subsystem 1	FC102	Danfoss	nvoDigitInput		N	0,0,0,0,0,0,0,0,0,0,1,0,0,0,0

130BA452.10

7

7 How to access IVS 102 parameters

In the [Field List:] under the section [par_number], enter the parameter number (in this example 3-41). If an indexed (array) parameter is accessed, the [subindex] field must be filled-in.

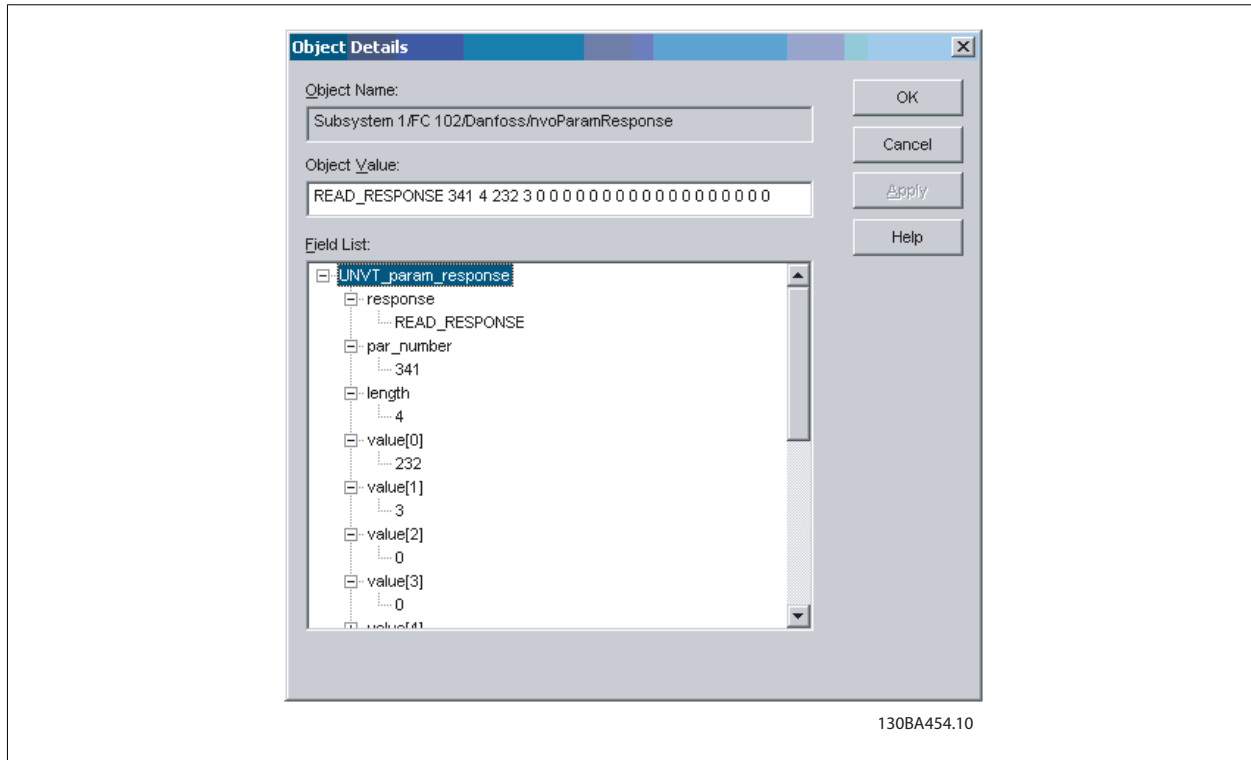

The response may look like this:

Value [0] (1st byte) = 232

Value [1] (2nd byte) = 3

-meaning that the readout value of parameter 3-41 is: $232 + (3 \times 256) = 1000$

Conversion index of par. 3-41 is: $-2(0.01)$

Ramp 1 Ramp-up Time = $1000 \times 0.01 = 10 \text{ seconds}$

8 Parameters

8.1 Parameter list

8.1.1 Parameter list

Par. No.	Parameter name:	Default value:	Range:	Conversion type:	Data type:
8-01	Control Site	Dig. and control word [0]	[0 - 2]	-	5
8-02	Control Word Source	IVS Port [1]	[0 - 4]	-	5
8-03	Control Word Timeout Time	600 s	0.1 - 18000	1	7
8-04	Control Word Timeout Function	Off [0]	[0 - 10]	-	5
8-05	End-of-timeout Function	Hold set-up [0]	[0 - 1]	-	5
8-06	Reset Control Word Timeout	Do not reset [0]	[0 - 1]	-	5
8-07	Diagnosis Trigger	Disable [0]	[0 - 3]	-	5
8-10	Control Word Profile	IVS profile [0]	[0 - x]	-	5
8-50	Coasting Select	Logic OR [3]	[0 - 3]	-	5
8-52	DC Brake Select	Logic OR [3]	[0 - 3]	-	5
8-53	Start Select	Logic OR [3]	[0 - 3]	-	5
8-54	Reversing Select	Logic OR [3]	[0 - 3]	-	5
8-55	Set-up Select	Logic OR [3]	[0 - 3]	-	5
8-56	Preset Reference Select	Logic OR [3]	[0 - 3]	-	5
11-00	Neuron ID	00 00 00 00 00 00	-	-	10
11-10	Drive Profile	VSD 6010 [0]	-	-	5
11-15	Lon Warning Word	0	-	-	6
11-18	LonWorks Revision	[0, 10]	-	-	9
11-21	Store Data Values	Off [0]	[0 - 1]	-	5

8

8.2 Parameter Group 8-**

8-01 Control Site

Option:

Function:

The setting in this parameter overrides the settings in par.8-50 *Coasting Select* to par.8-56 *Preset Reference Select*.

- [0] * Digital and ctrl.word Control by using both digital input and control word.
- [1] Digital only Control by using digital inputs only.
- [2] Controlword only Control by using control word only.

8-02 Control Source

Option:

Function:

Select the source of the control word: one of two serial interfaces or four installed options. During initial power-up, the frequency converter automatically sets this parameter to *Option A* [3] if it detects a valid fieldbus option installed in slot A. If the option is removed, the frequency converter detects a change in the configuration, sets par. 8-02 *Control Source* back to default setting *IVS Port*, and the frequency converter then trips. If an option is installed after initial power-up, the setting of par. 8-02 *Control Source* will not change but the frequency converter will trip and display: *Alarm 67 Option Changed*.

- [2] IVS USB
- [1] Drive Port
- [0] None
- [1] IVS Port

[2]	USB Port
[3] *	Option A
[4]	Option B
[5]	Option C0
[6]	Option C1



NB!
This parameter cannot be adjusted while the motor is running.

8-03 Control Timeout Time

Range:	Function:
60.0 s* [1.0 - 18000.0 s]	Enter the maximum time expected to pass between the reception of two consecutive telegrams. If this time is exceeded, it indicates that the serial communication has stopped. The function selected in par.8-04 <i>Control Timeout Function Control Time-out Function</i> will then be carried out. In LonWorks the following variables will trigger the Control Word Time parameter: <ul style="list-style-type: none"> nviStartStop nviReset Fault nviControlWord nviDrvSpeedStpt nviRefPcnt nviRefHz

8

8-04 Control Timeout Function

Option:	Function:
[0] * Off [1] Freeze output [2] Stop [3] Jogging [4] Max. speed [5] Stop and trip [7] Select setup 1 [8] Select setup 2 [9] Select setup 3 [10] Select setup 4 [20] N2 Override Release	Select the time-out function. The time-out function is activated when the control word fails to be updated within the time period specified in par.8-03 <i>Control Timeout Time</i> . Choice [20] only appears after setting the N2 protocol.

In LonWorks, the time-out function is also activated when the following SNVT's fail to be updated within the time period specified in par.8-03 *Control Timeout Time*:

- | | |
|----------------|-----------------|
| nviStartStop | nviDrvSpeedStpt |
| nviReset Fault | nviRefPcnt |
| nviControlWord | nviRefHz |

8-05 End-of-Timeout Function

Option:

Function:

Select the action after receiving a valid control word following a time-out. This parameter is active only when par.8-04 *Control Timeout Function* is set to [Set-up 1-4].

[0] Hold set-up

Retains the set-up selected in par.8-04 *Control Timeout Function* and displays a warning, until par. 8-06 *Reset Control Timeout* toggles. Then the frequency converter resumes its original set-up.

[1] * Resume set-up

Resumes the set-up active prior to the time-out.

8-06 Reset Control Timeout

Option:

Function:

This parameter is active only when the choice *Hold set-up* [0] has been selected in par.8-05 *End-of-Timeout Function*.

[0] * Do not reset

Retains the set-up specified in par.8-04 *Control Timeout Function*, [Select setup 1-4] following a control time-out.

[1] Do reset

Returns the frequency converter to the original set-up following a control word time-out. When the value is set to *Do reset* [1], the frequency converter performs the reset and then immediately reverts to the *Do not reset* [0] setting.

8-07 Diagnosis Trigger

Option:

Function:

This parameter has no function for LonWorks.

[0] * Disable

[1] Trigger on alarms

[2] Trigger alarm/warn.

8-10 Control Profile

Option:

Function:

Select the interpretation of the control and status words corresponding to the installed fieldbus. Only the selections valid for the fieldbus installed in slot A will be visible in the LCP display.

[0] * IVS profile

8-50 Coasting Select

Option:

Function:

Select control of the coasting function via the terminals (digital input) and/or via the bus.

[0] Digital input

[1] Bus

Activates Start command via the serial communication port or fieldbus option.

[2] Logic AND

Activates Start command via the fieldbus/serial communication port, AND additionally via one of the digital inputs.

[3] * Logic OR

Activates Start command via the fieldbus/serial communication port OR via one of the digital inputs.



NB!

This parameter is active only when par.8-01 *Control Site* is set to [0] *Digital and control word*.

8-51 Quick Stop Select

Select control of the Quick Stop function via the terminals (digital input) and/or via the bus.

Option:

Function:

[0] Digital Input

- [1] Bus
- [2] Logic AND
- [3] * Logic OR

**NB!**

This parameter is active only when par.8-01 *Control Site* is set to [0] *Digital and control word*.

8-52 DC Brake Select

Option:**Function:**

Select control of the DC brake via the terminals (digital input) and/or via the fieldbus.

- [0] Digital input
- [1] Bus Activates Start command via the serial communication port or fieldbus option.
- [2] Logic AND Activates Start command via the fieldbus/serial communication port, AND additionally via one of the digital inputs.
- [3] * Logic OR Activates Start command via the fieldbus/serial communication port OR via one of the digital inputs.

**NB!**

This parameter is active only when par.8-01 *Control Site* is set to [0] *Digital and control word*.

8-53 Start Select

Option:**Function:**

Select control of the frequency converter start function via the terminals (digital input) and/or via the fieldbus.

- [0] Digital input Activates Start command via a digital input.
- [1] Bus Activates Start command via the serial communication port or fieldbus option.
- [2] Logic AND Activates Start command via the fieldbus/serial communication port, AND additionally via one of the digital inputs.
- [3] * Logic OR Activates Start command via the fieldbus/serial communication port OR via one of the digital inputs.

**NB!**

This parameter is active only when par.8-01 *Control Site* is set to [0] *Digital and control word*.

8-54 Reversing Select

Option:**Function:**

Select control of the frequency converter reverse function via the terminals (digital input) and/or via the fieldbus.

- [0] * Digital input Activates Reverse command via a digital input.
- [1] Bus Activates Reverse command via the serial communication port or fieldbus option.
- [2] Logic AND Activates Reverse command via the fieldbus/serial communication port, AND additionally via one of the digital inputs.
- [3] Logic OR Activates Reverse command via the fieldbus/serial communication port OR via one of the digital inputs.

 **NB!**
 This parameter is active only when par.8-01 *Control Site* is set to [0] *Digital and control word*.

8-55 Set-up Select

Option:	Function:
	Select control of the frequency converter set-up selection via the terminals (digital input) and/or via the fieldbus.
[0] Digital input	Activates the set-up selection via a digital input.
[1] Bus	Activates the set-up selection via the serial communication port or fieldbus option.
[2] Logic AND	Activates the set-up selection via the fieldbus/serial communication port, AND additionally via one of the digital inputs.
[3] * Logic OR	Activate the set-up selection via the fieldbus/serial communication port OR via one of the digital inputs.

 **NB!**
 This parameter is active only when par.8-01 *Control Site* is set to [0] *Digital and control word*.

8-56 Preset Reference Select

Option:	Function:
	Select control of the frequency converter Preset Reference selection via the terminals (digital input) and/or via the fieldbus.
[0] Digital input	Activates Preset Reference selection via a digital input.
[1] Bus	Activates Preset Reference selection via the serial communication port or fieldbus option.
[2] Logic AND	Activates Preset Reference selection via the fieldbus/serial communication port, AND additionally via one of the digital inputs.
[3] * Logic OR	Activates the Preset Reference selection via the fieldbus/serial communication port OR via one of the digital inputs.

 **NB!**
 This parameter is active only when par.8-01 *Control Site* is set to [0] *Digital and control word*.

8.3 Parameter Group 11

11-00 Neuron ID

Range:	Function:
0 N/A* [0 - 0]	View the Neuron chip's unique Neuron ID number.
	View the Neuron chip's unique Neuron ID number.

11-10 Drive Profile

Option:	Function:
[0] * VSD profile	This parameter allows selecting between LONMARK Functional Profiles.
	The Armstrong Profile and the Node Object are common for all profiles.

11-15 LON Warning Word

Range:	Function:
0 N/A* [0 - FFFF]	This parameter contains the LON specific warnings.

Bit	Status
0	Internal fault
1	Internal fault
2	Internal fault
3	Internal fault
4	Internal fault
5	Reserved
6	Reserved
7	Reserved
8	Reserved
9	Invalid type change for changeable types
10	Initialization error
11	Internal communication error
12	Software revision mismatch
13	Bus not active
14	Option not present
15	LON input (nvi/nci) exceeds limits

11-17 XIF Revision

Range:	Function:
0 N/A* [0 - 0]	This parameter contains the version of the external interface file on the Neuron C chip on the LON option.

11-18 LonWorks Revision

Range:	Function:
0 N/A* [0 - 0]	This parameter contains the software version of the application program on the Neuron C chip on the LON option.

11-21 Store Data Values

Option:	Function:
	This parameter is used to activate storing of data in non-volatile memory.
[0] * Off	Store function is inactive.
[2] Store all setups	Stores all parameter values in the E ² PROM. The value returns to <i>Off</i> when all parameter values have been stored.

8

8.4 Data Types Supported by IVS 102

8.4.1 Object and Data Types Supported by IVS 102

Data type:	Description:
3	Integer 16
4	Integer 32
5	Unsigned 8
6	Unsigned 16
7	Unsigned 32
9	Visible string
10	Byte string
33	Standardized value (16 bit)
35	Bit sequence
41	Byte
42	Word

8.4.2 Conversion Index

This number refers to a conversion figure used when writing or reading to parameters.

Conversion index:	Conversion factor:
100	1
67	1 / 60
6	1000000
5	100000
4	10000
3	1000
2	100
1	10
0	1
-1	0.1
-2	0.01
-3	0.001
-4	0.0001
-5	0.00001
-6	0.000001

9 Troubleshooting

9.1 Alarm-, Warning and Extended Status Word

9.1.1 Alarm and warning messages

General

There is a clear distinction between alarms and warnings. In the event of an alarm, the frequency converter will enter a fault condition. After the cause for the alarm has been cleared, the master must acknowledge the alarm message in order to start operation of the frequency converter again. A warning, on the other hand, may appear when a warning condition arises, then disappear when conditions return to normal without interfering with the process.

Alarm Word and Warning Word are shown on the display in Hex format. If there is more than one warning or alarm, a sum of all warnings or alarms will be shown. Warning Word and Alarm Word are displayed in par. 16-90 to 16-95. For more information on the individual alarms and warnings, please refer to: *IVS 102 Drive Design Guide*.

Warnings

All warnings within the frequency converter are represented by a single bit within a Warning Word. A Warning Word is always an action parameter. Bit status FALSE [0] means no warning, while bit status TRUE [1] means warning. Each bit status has a corresponding text string message. In addition to the Warning Word message the master will also be notified via a change to bit 7 in the status word.

Alarms

Following an alarm message the frequency converter will enter a fault condition. Only after the fault has been rectified and the master has acknowledged the alarm message by setting bit 3 in the Control Word, can the IVS resume operation. All alarms within the IVS are represented by a single bit within an Alarm Word. An Alarm Word is always an action parameter. Bit status FALSE [0] means no alarm, while bit status TRUE [1] means alarm.

9.1.2 Alarm words

Alarm word, par. 16-90 *Alarm Word*

Bit (Hex)	Alarm Word (par. 16-90 <i>Alarm Word</i>)
00000001	Brake check
00000002	Power card over temperature
00000004	Earth fault
00000008	Ctrl. card over temperature
00000010	Control word timeout
00000020	Over current
00000040	Torque limit
00000080	Motor thermistor over temp.
00000100	Motor ETR over temperature
00000200	Inverter overloaded
00000400	DC link under voltage
00000800	DC link over voltage
00001000	Short circuit
00002000	Inrush fault
00004000	Mains phase loss
00008000	AMA not OK
00010000	Live zero error
00020000	Internal fault
00040000	Brake overload
00080000	Motor phase U is missing
00100000	Motor phase V is missing
00200000	Motor phase W is missing
00400000	Fieldbus fault
00800000	24V supply fault
01000000	Mains failure
02000000	1.8V supply fault
04000000	Brake resistor short circuit
08000000	Brake chopper fault
10000000	Option change
20000000	Drive initialized
40000000	Safe Stop
80000000	Not used

Alarm word 2, par. 16-91 *Alarm Word 2*

Bit (Hex)	Alarm Word 2 (par. 16-91 <i>Alarm Word 2</i>)
00000001	Service Trip, read / Write
00000002	Reserved
00000004	Service Trip, Typecode / Sparepart
00000008	Reserved
00000010	Reserved
00000020	No Flow
00000040	Dry Pump
00000080	End of Curve
00000100	Broken Belt
00000200	Not used
00000400	Not used
00000800	Reserved
00001000	Reserved
00002000	Reserved
00004000	Reserved
00008000	Reserved
00010000	Reserved
00020000	Not used
00040000	Fans error
00080000	ECB error
00100000	Reserved
00200000	Reserved
00400000	Reserved
00800000	Reserved
01000000	Reserved
02000000	Reserved
04000000	Reserved
08000000	Reserved
10000000	Reserved
20000000	Reserved
40000000	Reserved
80000000	Reserved

9.1.3 Warning words

Warning word , par. 16-92 *Warning Word*

Bit (Hex)	Warning Word (par. 16-92 <i>Warning Word</i>)
00000001	Brake check
00000002	Power card over temperature
00000004	Earth fault
00000008	Ctrl. card over temperature
00000010	Control word timeout
00000020	Over current
00000040	Torque limit
00000080	Motor thermistor over temp.
00000100	Motor ETR over temperature
00000200	Inverter overloaded
00000400	DC link under voltage
00000800	DC link over voltage
00001000	DC link voltage low
00002000	DC link voltage high
00004000	Mains phase loss
00008000	No motor
00010000	Live zero error
00020000	10V low
00040000	Brake resistor power limit
00080000	Brake resistor short circuit
00100000	Brake chopper fault
00200000	Speed limit
00400000	Fieldbus comm. fault
00800000	24V supply fault
01000000	Mains failure
02000000	Current limit
04000000	Low temperature
08000000	Voltage limit
10000000	Encoder loss
20000000	Output frequency limit
40000000	Not used
80000000	Not used

Warning word 2, par. 16-93 *Warning Word 2*

Bit (Hex)	Warning Word 2 (par. 16-93 <i>Warning Word 2</i>)
00000001	Start Delayed
00000002	Stop Delayed
00000004	Clock Failure
00000008	Reserved
00000010	Reserved
00000020	No Flow
00000040	Dry Pump
00000080	End of Curve
00000100	Broken Belt
00000200	Not used
00000400	Reserved
00000800	Reserved
00001000	Reserved
00002000	Reserved
00004000	Reserved
00008000	Reserved
00010000	Reserved
00020000	Not used
00040000	Fans warning
00080000	ECB warning
00100000	Reserved
00200000	Reserved
00400000	Reserved
00800000	Reserved
01000000	Reserved
02000000	Reserved
04000000	Reserved
08000000	Reserved
10000000	Reserved
20000000	Reserved
40000000	Reserved
80000000	Reserved

9.2 Extended Status Word

9.2.1 Extended status words

Extended status word, par. 16-94 *Ext. Status Word*

Bit (Hex)	Extended Status Word (par. 16-94 <i>Ext. Status Word</i>)
00000001	Ramping
00000002	AMA tuning
00000004	Start CW/CCW
00000008	Not used
00000010	Not used
00000020	Feedback high
00000040	Feedback low
00000080	Output current high
00000100	Output current low
00000200	Output frequency high
00000400	Output frequency low
00000800	Brake check OK
00001000	Braking max
00002000	Braking
00004000	Out of speed range
00008000	OVC active
00010000	AC brake
00020000	Password Timelock
00040000	Password Protection
00080000	Reference high
00100000	Reference low
00200000	Local Ref./Remote Ref.
00400000	Reserved
00800000	Reserved
01000000	Reserved
02000000	Reserved
04000000	Reserved
08000000	Reserved
10000000	Reserved
20000000	Reserved
40000000	Reserved
80000000	Reserved

Extended status word 2, par. 16-95 *Ext. Status Word 2*

Bit (Hex)	Extended Status Word 2 (par. 16-95 <i>Ext. Status Word 2</i>)
00000001	Off
00000002	Hand / Auto
00000004	Not used
00000008	Not used
00000010	Not used
00000020	Relay 123 active
00000040	Start Prevented
00000080	Control ready
00000100	Drive ready
00000200	Quick Stop
00000400	DC Brake
00000800	Stop
00001000	Standby
00002000	Freeze Output Request
00004000	Freeze Output
00008000	Jog Request
00010000	Jog
00020000	Start Request
00040000	Start
00080000	Start Applied
00100000	Start Delay
00200000	Sleep
00400000	Sleep Boost
00800000	Running
01000000	Bypass
02000000	Fire Mode
04000000	Reserved
08000000	Reserved
10000000	Reserved
20000000	Reserved
40000000	Reserved
80000000	Reserved

9.3 Reference Scaling - Examples

9.3.1 Reference Scaling - Open Loop

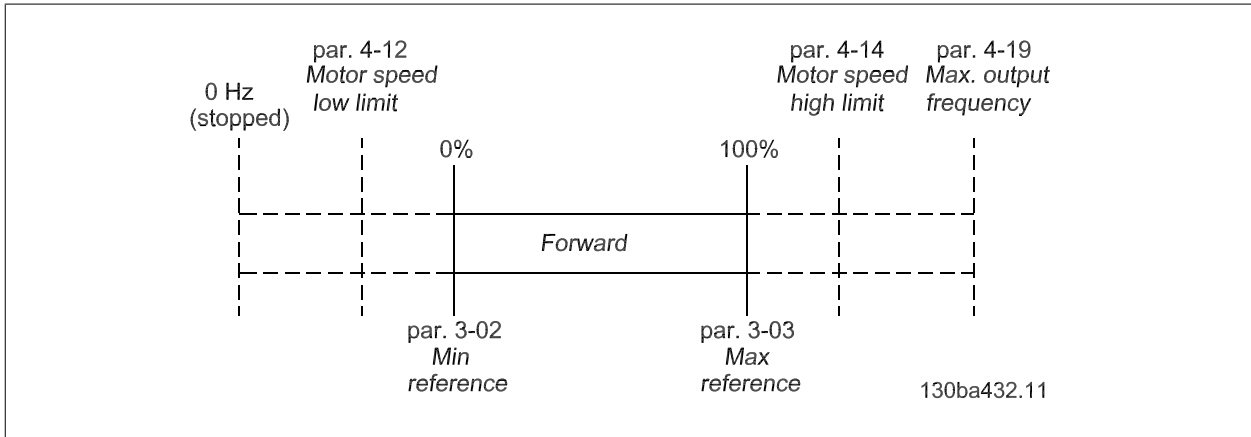

Example:

- par. 3-02 *Minimum Reference* = 100 RPM
- par. 3-03 *Maximum Reference* = 1500 RPM
- Reference send = 1500 hex (5376 dec)

Output:

The output can be calculated as:

$$\frac{\text{Reference (decimal)} * (\text{par.3-03} - \text{par.3-02})}{16384} + \text{par.3-02} =$$

$$\frac{5376 * (1500 - 100)}{16384} + 100 = \mathbf{559 \text{ RPM}}$$

9.4 Network Variables - Overview

9.4.1 Output variables (nvo)

Variable function	Variable name	SNVT type	Profile	IVS 102 par.
Status word	nvoStatusword	SNVT_state	IVS VSD	16-03
Drive output [%]	nvoOutputPcnt	SNVT_lev_percent	IVS VSD	16-05
Drive output [Hz]	nvoOutputHz	SNVT_freq_hz	IVS VSD	16-13
kWh counter	nvoDrvEnrg	SNVT_elec_kwh_l	IVS VSD	15-02
DC Link Voltage	nvoDCVoltage	SNVT_volt	IVS VSD	16-30
Motor thermal	nvoTempMtr	SNVT_lev_cont	IVS VSD	16-18
Inverter Thermal	nvoTempInvrtr	SNVT_lev_cont	IVS VSD	16-35
Closed loop feedback	nvoFeedback	SNVT_count_inc_f	IVS VSD	16-52
Fanbelt broken	nvoBrokenBelt	SNVT_switch	IVS VSD	16-93
Alarm flag	nvoAlarm	SNVT_switch	IVS VSD	16-90
Warning flag	nvoWarning	SNVT_switch	IVS VSD	16-03
Alarm word	nvoAlarmword	SNVT_state_64	IVS VSD	16-90 + 16-91
Warning word	nvoWarningword	SNVT_state_64	IVS VSD	16-92 + 16-93
Extended statusword	nvoExtendedStatusword	SNVT_state_64	IVS VSD	16-94 + 16-95
Digital inputs	nvoDigitInput	SNVT_state_64	IVS VSD	16-60
Analog Input (53)	nvoAnIn1	SNVT_volt/SNVT_amp_mil/SNVT_lev_percent	IVS VSD	16-62
Analog Input (54)	nvoAnIn2	SNVT_volt/SNVT_amp_mil/SNVT_lev_percent	IVS VSD	16-64
Analog Input (X30/11)	nvo101AnIn1	SNVT_volt/SNVT_lev_percent	IVS VSD	16-75
Analog Input (X30/12)	nvo101AnIn2	SNVT_volt/SNVT_lev_percent	IVS VSD	16-76
Analog Input (X42/1)	nvo109AnIn1	SNVT_volt/SNVT_temp_p/SNVT_lev_percent	IVS VSD	18-30
Analog Input (X42/3)	nvo109AnIn2	SNVT_volt/SNVT_temp_p/SNVT_lev_percent	IVS VSD	18-31
Analog Input (X42/5)	nvo109AnIn3	SNVT_volt/SNVT_temp_p/SNVT_lev_percent	IVS VSD	18-32
ECB option status	nvoECBstatus	SNVT_state	IVS VSD	31-10
Parameter access cmd.	nvoParamResponse	UNVT_param_response	IVS VSD	-
Drive Speed	nvoDrvSpeed	SNVT_lev_percent	VSD 6010	16-05
Output current	nvoDrvCurnt	SNVT_amp	VSD 6010	16-14
Output voltage	nvoDrvVolt	SNVT_volt	VSD 6010	16-12
Output power	nvoDrvPwr	SNVT_power_kilo	VSD 6010	16-10
Running hours	nvoDrvRunHours	SNVT_time_hour	VSD 6010	15-01
Object Status	nvoStatus	SNVT_obj_status	Node obj.	-

9.4.2 Input variables (nvi)

Variable Function	Variable Name	SNVT type	Profile	IVS 102 par.
Start/Stop	nviStartStop	SNVT_switch	IVS VSD	CTW/reference
Control word	nviControlword	SNVT_state	IVS VSD	CTW
Reset fault	nviResetFaut	SNVT_switch	IVS VSD	CTW
Reference [%]	nviRefPcnt	SNVT_lev_percent	IVS VSD	Reference
Reference [Hz]	nviRefHz	SNVT_freq_hz	IVS VSD	Reference
CL Setpoint 1	nviSetpoint1	SNVT_lev_percent	IVS VSD	20-21
CL Setpoint 2	nviSetpoint2	SNVT_lev_percent	IVS VSD	20-22
CL Setpoint 3	nviSetpoint3	SNVT_lev_percent	IVS VSD	20-23
Bus feedback 1	nviFeedback1	SNVT_lev_percent	IVS VSD	8-94
Bus feedback 2	nviFeedback2	SNVT_lev_percent	IVS VSD	8-95
Bus feedback 3	nviFeedback3	SNVT_lev_percent	IVS VSD	8-96
Digital/relay outputs	nviDigiOutput	SNVT_state_64	IVS VSD	5-90
Analog output (42)	nviAnOut1	SNVT_lev_percent	IVS VSD	6-53
Analog output (X30/8)	nvi101AnOut1	SNVT_lev_percent	IVS VSD	6-63
Analog output (X42/7)	nvi109AnOut1	SNVT_lev_percent	IVS VSD	26-43
Analog output (X42/9)	nvi109AnOut2	SNVT_lev_percent	IVS VSD	26-53
Analog output (X42/11)	nvi109AnOut3	SNVT_lev_percent	IVS VSD	26-63
Setting of RTC	nviTimeStamp	SNVT_time_stamp	IVS VSD	0-70
ECB option Mode	nviECBMode	SNVT_state	IVS VSD	31-00
ECB By-pass activation	nviECBActivation	SNVT_switch	IVS VSD	31-19
Parameter access command	nviParamRequest	UNVT_param_request	IVS VSD	-
Drive speed setpoint	nviDrvSpeedStpt	SNVT_switch	VSD 6010	CTW / Reference
Standard Node Object	nviRequest	SNVT_obj_request	Node obj.	-



9.4.3 Configuration properties (nci)

Variable function	Variable name	SNVT type	Profile	IVS 102 parameter
Max. motor speed [%]	nciMaxSpeed	SNVT_lev_percent	VSD 6010	4-13
Min. motor speed [%]	nciMinSpeed	SNVT_lev_percent	VSD 6010	4-11
Nom. motor speed [RPM]	nciNmlSpeed	SNVT_rpm	VSD 6010	1-25
Nom. motor frequency [Hz]	nciNmlFreq	SNVT_freq_hz	VSD 6010	1-23
Min. ramp-up time [s]	nciRampUpTime	SNVT_time_sec	VSD 6010	3-41
Min. ramp-down time [s]	nciRampDownTime	SNVT_time_sec	VSD 6010	3-42
Heartbeat time [s]	nciSndHrtBt	SNVT_time_sec	VSD 6010	-
Max Send Time (Heartbeat)	nciMaxStsSendT	SNVT_elapsed_tm	Node obj.	-
Min Send Time (Inhibit timer)	nciMinSendT	SNVT_elapsed_tm	Virtual obj.	-

Index

A

Abbreviations	8
About This Manual	6
Alarm And Warning Messages	53
Alarm Flag	26
Alarm Word	54
Alarm Word	26
Analog Input (53)	27
Analog Input (54)	28
Analog Input (x30/11)	28
Analog Input (x30/12)	28
Analog Input (x42/1)	29
Analog Input (x42/3)	29
Analog Input (x42/5)	29
Analog Output (42)	21
Analog Output (x30 / 8)	22
Analog Output (x42 / 7)	22
Analog Output (x42 / 9)	22
Analog Output (x42 /11)	22
Assumptions	6

B

Background Knowledge	7
Bus Feedback 1-3	20
Bus Line	11

C

Cable Lengths	11
Cabling	9
Closed Loop Feedback	25
Closed Loop Set-point 1-3	20
Coasting Select 8-50	48
Configuration Properties (nci)	59
Configuration Properties (nci)	32
Configure The Lonworks Network	16
Control Site 8-01	46
Control Timeout Function 8-04	47
Control Timeout Time 8-03	47
Control Word	19
Control Word Time-out Function	37
Conversion Index	52
Copyright, Limitation Of Liability And Revision Rights	3

D

Dc Brake Select 8-52	49
[Dc Link Voltage V]	25
Diagnosis Trigger 8-07	48
Digital / Relay Outputs	21
Digital Inputs	27
[Drive Output %]	24
[Drive Output Hz]	24
Drive Speed	33

E

Ecb Option Mode	23
Ecb Option Status	30
Ecb Remote By-pass Activation	23
Emc Precautions	12
End-of-timeout Function 8-05	48
Example: Read Parameter 3-41	43
Explanation Of The Control Bits	39
Explanation Of The Status Bits	41
Extended Status Word	56

Extended Status Word	27
Extended Status Word 2	56
F	
Fanbelt Broken	25
IVS Control Profile	39
IVS Vsd Profile	17
IVS Vsd Profile - Input	19
Fieldbus Option	14
Frequency Converter Speed Setpoint	32
Functional Profiles	16
H	
Hardware	6
[Heartbeat Time S]	35
How To Install Option In Frequency Converter	14
I	
Input Variables	17
Input Variables	31
Input Variables (nvi)	59
Installation At High Altitudes	4
[Inverter Thermal %]	25
K	
[Kwh Counter Kwh]	24
L	
Least Significant Bit (lsb)	24, 26, 27
Led Behaviour	13
Lon	6, 0
Lon Technology	6, 0
Lonmark Certification	7
Lonworks Communication Structure	0
Lonworks Option	9
M	
[Max Motor Speed %]	34
Max. Send Time (heartbeat)	36
[Min Motor Speed %]	34
[Min Ramp-down Time S]	35
[Min Ramp-up Time S]	35
Min. Send Time (inhibit Timer)	47
[Motor Thermal %]	25
N	
Network Termination	10
Network Variable Description	19
Neuron Id Label	16
Node Object	36
[Nom Motor Speed Rpm]	34
[Nominal Motor Frequency Hz]	34
Non-volatile Memory	32
O	
Object And Data Types Supported By	52
Object Request	36
Object Response	36
Output Current	33
Output Power	33
Output Variables	18
Output Variables	31

Output Variables (nvo)	58
Output Voltage	33
P	
Parameter Access Command	23
Parameter Access Response	30
Parameter List	46
Preset Reference Select 8-56	50
Q	
Query And Wink	16
Quick Stop Select 8-51	48
R	
[Reference %]	20
Reference Handling	38
[Reference Hz]	20
Reference Scaling - Open Loop	57
Related Literature For The	7
Reset Control Timeout 8-06	48
Reset Fault	19
Resource Files	16
Reversing Select 8-54	49
Running Hours	33
S	
Safety Note	4
Safety Regulations	4
Service Pin	16
Setting Of Rtc	23
Set-up Select 8-55	50
Start Select 8-53	49
Start/stop	19
Status Word	24
Status Word According To IVS Profile (stw)	40
Store Data Values 11-21	51
System Specifications	11
T	
Technical Overview	6
U	
Unvt Parameter Structure	42
Unvt_param_request	42
Unvt_param_response	42
W	
Warning Against Unintended Start	4
Warning Flag	26
Warning Word	55
Warning Word	26
Warning Word 2	55