

## DESIGN ENVELOPE 4300 VIL | 0308-003.0 | SUBMITTAL

**File No:** 100.4044  
**Date:** DECEMBER 17, 2015  
**Supersedes:** 100.4050  
**Date:** AUGUST 14, 2015

Job: \_\_\_\_\_ Representative: \_\_\_\_\_

Order No: \_\_\_\_\_ Date: \_\_\_\_\_

Engineer: \_\_\_\_\_ Submitted by: \_\_\_\_\_ Date: \_\_\_\_\_

Contractor: \_\_\_\_\_ Approved by: \_\_\_\_\_ Date: \_\_\_\_\_

### PUMP DESIGN DATA

No. of pumps: \_\_\_\_\_ Tag: \_\_\_\_\_

Capacity: \_\_\_\_\_ USgpm (L/s) Head: \_\_\_\_\_ ft (m)

Liquid: \_\_\_\_\_ Viscosity: \_\_\_\_\_

Temperature: \_\_\_\_\_ °F (°C) Specific gravity: \_\_\_\_\_

Suction: 3" (75mm) Discharge: 3" (75mm)

**OSHPD Seismic Certification OSP-0422-10**

**UL STD 778 & CSA STD C22.2 NO.108 certified**

### MOTOR DESIGN DATA

HP: \_\_\_\_\_ RPM: \_\_\_\_\_ Frame size: \_\_\_\_\_ Enclosure: \_\_\_\_\_

Volts: \_\_\_\_\_ Hertz: 60 Hz Phase: 3

Efficiency: NEMA premium 12.12

### MAXIMUM PUMP OPERATING CONDITIONS

#### ANSI 125

175 psig at 150°F (12 bars at 65°C)

100 psig at 300°F (7 bars at 150°C)

#### ANSI 250

375 psig at 150°F (26 bars at 65°C)

260 psig at 300°F (21 bars at 150°C)

- Tolerance of ±0.125" (±3 mm) should be used
- For exact installation, data please write factory for certified dimensions

### MECHANICAL SEAL DESIGN DATA

See file no. 43.50 for standard mechanical seal details as indicated below

Armstrong seal reference number

c1 (a)  Others: \_\_\_\_\_

### CONTROLS DATA

**Sensorless Control:** Standard

**Minimum system pressure to be maintained:** \_\_\_\_\_ ft (m)\*

**Orientation:**  L1 (default)  L2  L3  L4

**Protocol (standard):**  Modbus RTU  BACnet™ MS/TP  
 Johnson® N2  Siemens® FLN

**Protocol (optional):**  LonWorks®

**Enclosure:**  Indoor - UL TYPE 12  
 Outdoor - UL TYPE 4X with Weather Shield  
 Outdoor - UL TYPE 4X less Weather Shield

**Fused disconnect switch:**

**EMI/RFI control:** Integrated filter designed to meet EN61800-3

**Harmonic suppression:** Dual dc-link reactors (Equivalent: 5% AC line reactor) Supporting IEEE 519-1992 requirements\*\*

**Cooling:** Fan-cooled through back channel

**Ambient temperature:** -10°C to +45°C up to 1000 meters above sea level (-14°F to +113°F, 3300 ft)

**Analog I/O:** Two current or voltage inputs, one current output

**Digital I/O:** Six programmable inputs (two can be configured as outputs)

**Pulse inputs:** Two programmable

**Relay outputs:** Two programmable

**Communication port:** 1-RS485, 1-USB

\*If minimum maintained system pressure is not known: Default to 40% of design head

\*\*The IVS 102 drive is a low harmonic drive via built-in dc line reactors. This does not guaranty performance to any system wide harmonic specification or the costs to meet a system wide specification. If supplied with the system electrical details, Armstrong will run a computer simulation of the system wide harmonics. If system harmonic levels are exceeded Armstrong can also recommend additional harmonic mitigation and the costs for such mitigation.

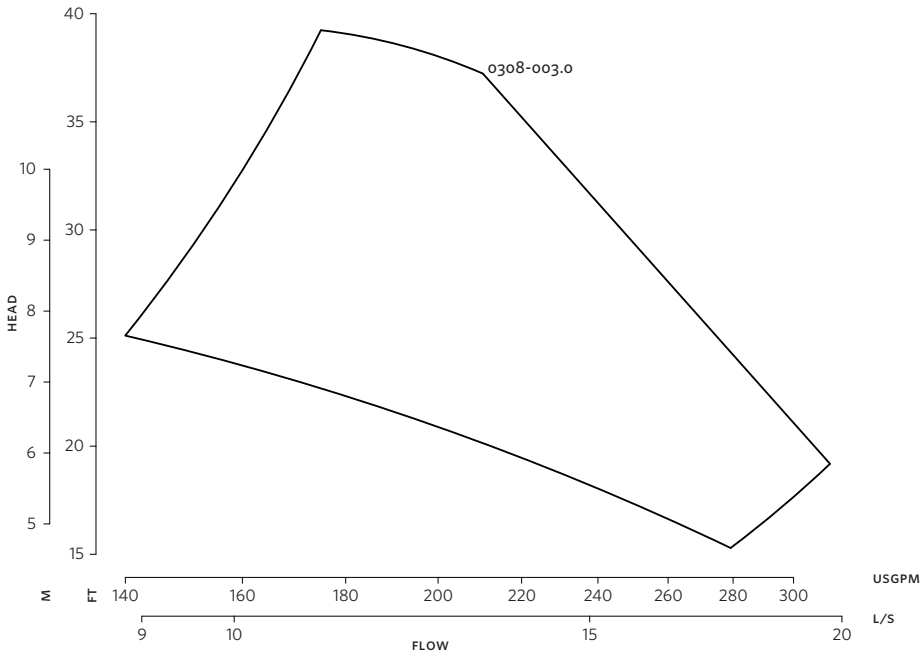

**DIMENSION DATA**

	INDOOR (UL TYPE 12/ODP)	OUTDOOR (UL TYPE 4X/TEFC)
<b>Frame size:</b>	182	182
<b>Size:</b>	3×3×8	3×3×8
<b>HP:</b>	3	3
<b>RPM:</b>	1800	1800
<b>AB:</b>	27.55(700)	33.51(851)
<b>B:</b>	6.75(171)	6.75(171)
<b>C:</b>	5.80(147)	5.80(147)
<b>D:</b>	10.00(254)	10.00(254)
<b>E:</b>	12.56(319)	17.83(453)
<b>P:</b>	10.38(264)	9.56(243)
<b>S:</b>	12.00(305)	12.00(305)
<b>SD:</b>	22.00(559)	22.00(559)
<b>T:</b>	6.31(160)	6.31(160)
<b>XY:</b>	26.54(674)	26.42(671)
<b>Weight:</b>	279(126.6)	310(140.6)

Performance curves are for reference only.  
Confirm current performance data with Armstrong ACE Online selection software.

Dimensions - inch (mm)  
Weight - lbs (kg)

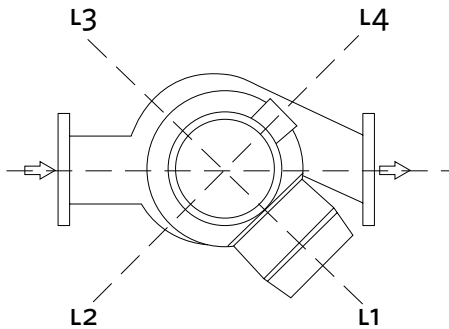

**TORONTO**  
+1 416 755 2291

**BUFFALO**  
+1 716 693 8813

**BIRMINGHAM**  
+44 (0) 8444 145 145

**MANCHESTER**  
+44 (0) 8444 145 145

**BANGALORE**  
+91 (0) 80 4906 3555

**SHANGHAI**  
+86 21 3756 6696

