

## DESIGN ENVELOPE 4300 VIL SINGLE PHASE | 0208-001.5 | SUBMITTAL

File No: 100.4275  
Date: OCTOBER 27, 2014  
Supersedes: NEW  
Date: NEW

Job: \_\_\_\_\_ Representative: \_\_\_\_\_

Order No: \_\_\_\_\_ Date: \_\_\_\_\_

Engineer: \_\_\_\_\_ Submitted by: \_\_\_\_\_ Date: \_\_\_\_\_

Contractor: \_\_\_\_\_ Approved by: \_\_\_\_\_ Date: \_\_\_\_\_

### PUMP DESIGN DATA

No. of pumps: \_\_\_\_\_ Tag: \_\_\_\_\_  
Capacity: \_\_\_\_\_ USgpm (L/s) Head: \_\_\_\_\_ ft (m)  
Liquid: \_\_\_\_\_ Viscosity: \_\_\_\_\_  
Temperature: \_\_\_\_\_ °F (°C) Specific gravity: \_\_\_\_\_  
Suction: 2" (50mm) Discharge: 2" (50mm)

### MOTOR DESIGN DATA

HP: 1.5 RPM: 1450 Frame size: \_\_\_\_\_  
Enclosure: \_\_\_\_\_ Volts: 208 Freq: 60 Hz  
Phase: 3 Efficiency: NEMA premium

### MAXIMUM PUMP OPERATING CONDITIONS

#### ANSI 125

175 psig at 150°F (12 bars at 65°C)  
100 psig at 300°F (7 bars at 150°C)

#### ANSI 250

375 psig at 150°F (26 bars at 65°C)  
260 psig at 300°F (21 bars at 150°C)

- Tolerance of ±0.125" (±3 mm) should be used
- For exact installation, data please write factory for certified dimensions

### MECHANICAL SEAL DESIGN DATA

See file no. 43.50 for standard mechanical seal details as indicated below

Armstrong seal reference number

A1 (C)  Others: \_\_\_\_\_

### CONTROLS DATA

Power supply: Volts: 200-240VAC  
Freq: 50/60Hz Phase: 1

Sensorless Control: Standard

Minimum system pressure to be maintained: \_\_\_\_\_ ft (m)\*

Orientation:  L1 (default)  L2  L3  L4

Protocol (standard):  Modbus RTU  BACnet™ MS/TP  
 Johnson® N2  Siemens® FLN

Protocol (optional):  LonWorks®

Enclosure:  Indoor - UL TYPE 12  
 Outdoor - UL TYPE 4X with Weather Shield  
 Outdoor - UL TYPE 4X less Weather Shield

Disconnect switch:  Non-fused

EMI/RFI control: 1-phase IVS102 units do not meet the EN61800-3 directive

Harmonic suppression: Dual DC-link reactors (Equivalent: 5% AC line reactor) Supporting IEEE 519-1992 requirements\*\*

Cooling: Fan-cooled through back channel

Ambient temperature: -10°C to +45°C up to 1000 meters above sea level (-14°F to +113°F, 3300 ft)

Analog I/O: Two current or voltage inputs, one current output

Digital I/O: Six programmable inputs (two can be configured as outputs)

Pulse inputs: Two programmable

Relay outputs: Two programmable

Communication port: 1-RS485, 1-USB

\*If minimum maintained system pressure is not known: Default to 40% of design head  
\*\*The IVS 102 drive is a low harmonic drive via built-in DC line reactors. This does not guaranty performance to any system wide harmonic specification or the costs to meet a system wide specification. If supplied with the system electrical details, Armstrong will run a computer simulation of the system wide harmonics. If system harmonic levels are exceeded Armstrong can also recommend additional harmonic mitigation and the costs for such mitigation.

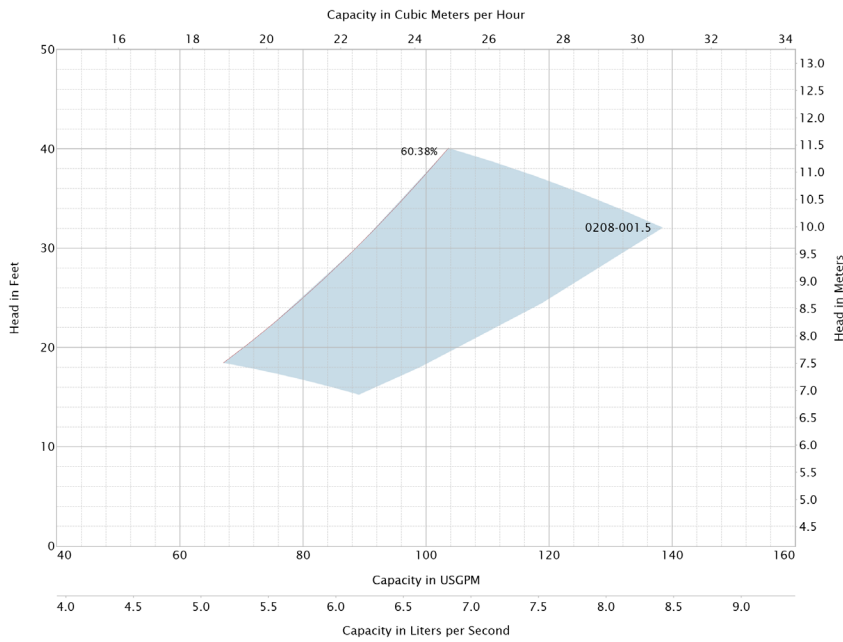

**DIMENSION DATA**

	INDOOR (UL TYPE 12/ODP)	OUTDOOR (UL TYPE 4X/TEFC)
<b>Frame size:</b>	145	145
<b>Size:</b>	2×2×8	2×2×8
<b>HP:</b>	1.5	1.5
<b>RPM:</b>	1450	1450
<b>AB:</b>	23.83(605)	29.96(761)
<b>B:</b>	5.80(147)	5.80(147)
<b>C:</b>	5.80(147)	5.80(147)
<b>D:</b>	8.50(216)	8.50(216)
<b>E:</b>	12.04(306)	17.21(437)
<b>F:</b>	12.04(306)	17.19(437)
<b>P:</b>	8.63(219)	7.28(185)
<b>S:</b>	9.50(241)	9.50(241)
<b>SD:</b>	18.00(457)	18.00(457)
<b>T:</b>	5.09(129)	5.09(129)
<b>XY:</b>	22.03(560)	20.53(521)
<b>Weight:</b>	229(103.9)	237(107.5)

Performance curves are for reference only.  
Confirm current performance data with Armstrong ACE Online selection software.

Dimensions - inch (mm)  
Weight - lbs (kg)

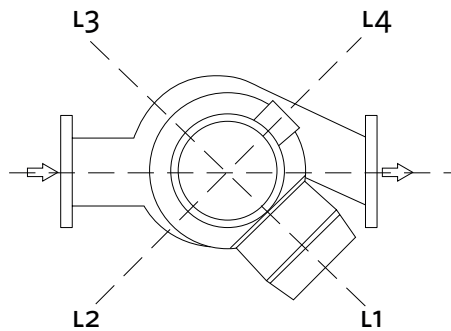

**TORONTO**  
+1 416 755 2291

**BUFFALO**  
+1 716 693 8813

**BIRMINGHAM**  
+44 (0) 8444 145 145

**MANCHESTER**  
+44 (0) 8444 145 145

**BANGALORE**  
+91 (0) 80 4906 3555

**SHANGHAI**  
+86 21 3756 6696

