

DESIGN ENVELOPE 4302 DUALARM | 0810-020.0 | SUBMITTAL

File No: 104.5065
Date: DECEMBER 16, 2020
Supersedes: 104.5065
Date: JULY 8, 2019

Job: _____ Representative: _____

Order No: _____ Date: _____

Engineer: _____ Submitted by: _____ Date: _____

Contractor: _____ Approved by: _____ Date: _____

PUMP DESIGN DATA

No. of pumps: _____ Tag: _____
Total system design flow: _____ USgpm(L/s)
Head: _____ ft(m) Capacity split _____ %
Flow per pump head: _____ USgpm(L/s)
Parallel flow: _____ USgpm(L/s)
Liquid: _____ Viscosity: _____
Temperature: _____ °F (°C) Specific gravity: _____
Suction: 8" (200mm) Discharge: 8" (200mm)

**OSHPD Seismic Certification OSP-0422-10
UL STD 778 & CSA STD C22.2 NO.108 certified
Test report is supplied with each pump**

MOTOR DESIGN DATA

HP: _____ RPM: _____ Frame size: _____
Enclosure: _____ Volts: _____ Hertz: 60 Hz
Phase: 3 Efficiency: NEMA premium 12.12

MAXIMUM PUMP OPERATING CONDITIONS

ANSI 125 - (CONSTRUCTION: BF)

175 psig at 150°F (12 bar at 65°C)
140 psig at 250°F (10 bar at 121°C)

MECHANICAL SEAL DESIGN DATA

See file no. 43.50 for standard mechanical seal details as indicated below

Armstrong seal reference number

c1 (a) Others: _____

CONTROLS DATA

Protocol (standard): BACnet™ MS/TP

BACnet™ TCP/IP

Modbus RTU

Enclosure: Indoor - UL TYPE 12

Outdoor - UL TYPE 4X with Weather Shield

Outdoor - UL TYPE 4X less Weather Shield

Fused disconnect switch:

EMI/RFI control: Integrated filter designed to meet EN61800-3

Harmonic suppression: Dual DC-link reactors (Equivalent: 5% AC line reactor) Supporting IEEE 519-1992 requirements**

Cooling: Fan-cooled through back channel

Ambient temperature: -10°C to +45°C up to 1000 meters above sea level (+14°F to +113°F, 3300 ft)

Analog I/O: Two current or voltage inputs, one speed output

Digital I/O: Two inputs, two outputs

Pulse inputs: Two programmable

Relay outputs: Two programmable

Communication port: 1-RS485

** The IVS drive is a low harmonic drive via built-in DC line reactors. This does not guaranty performance to any system wide harmonic specification or the costs to meet a system wide specification. If supplied with the system electrical details, Armstrong will run a computer simulation of the system wide harmonics. If system harmonic levels are exceeded Armstrong can also recommend additional harmonic mitigation and the costs for such mitigation.

FLOW READOUT ACCURACY

The Design Envelope model selected will provide flow reading on the controls local keypad & digitally for the BMS. The model readout will be factory tested to ensure ±5% accuracy.

OPTIONS

SENSORLESS BUNDLE (STANDARD)



Operation of pump without a remote sensor. Includes:

- Sensorless control
- Flow readout
- Constant flow
- Constant pressure

Minimum system pressure to be maintained _____ ft (m)

* If minimum maintained system pressure is not known: Default to 40% of design head

PARALLEL SENSORLESS



Operation of multiple pumps without a remote sensor

Minimum system pressure to be maintained _____ ft (m)

* If minimum maintained system pressure is not known: Default to 40% of design head

ENERGY PERFORMANCE BUNDLE



Provides energy savings on oversized systems by adjusting pump parameters to on-site conditions. Includes:

- **Auto-flow balancing** - Automatically determines control curve between design flow at on-site system head, and minimum (zero-head) flow for energy savings
- **Maximum flow control** - Limits flow rate to pre-set maximum for potential energy savings

Maximum flow rate _____ gpm (L/s)

*Only available if sensorless bundle is enabled

*Available in single pump operation only

PROTECTION BUNDLE



Protects other flow sensitive equipment by setting limits of pump operation. Includes:

- **Minimum flow control** - Attempts to maintain flow rate to pre-set minimum to protect equipment in system
- **Bypass valve control** - Actuates a bypass valve to protect flow sensitive equipment if pre-set minimum flow rate is reached

Minimum flow rate _____ gpm (L/s)

*Only available if sensorless bundle is enabled

DUAL SEASON SETUP



Pre-sets heating and cooling parameters for pumps in 2-pipe systems

Cooling

Duty point _____ gpm (L/s) at _____ ft (m)

Minimum system pressure to be maintained _____ ft (m)

Heating

Duty point _____ gpm (L/s) at _____ ft (m)

Minimum system pressure to be maintained _____ ft (m)

*Available in single pump operation only

OPTIONAL SERVICES

ON-SITE PUMP COMMISSIONING



PUMP MANAGER



Online service for sustained pump performance and enhanced reliability.

Available in 3 or 5 year terms

* Requires an internet connection to be provided by building

* Includes an extended warranty for parts and labour

(wearable parts excluded)

3

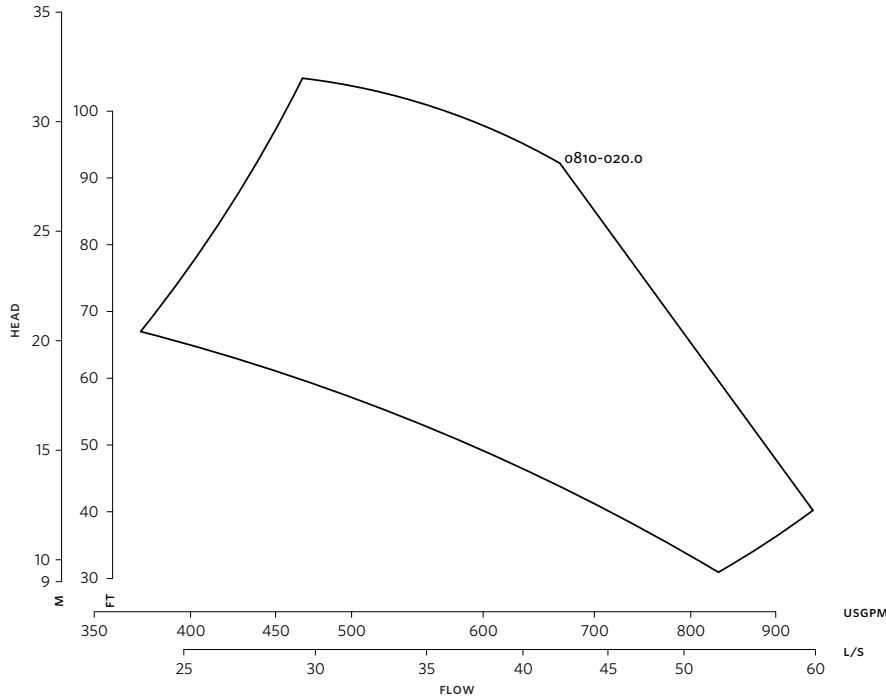

DIMENSION DATA

	INDOOR (UL TYPE 12/ODP)	OUTDOOR (UL TYPE 4X/TEFC)
Frame size:	256	256
Size:	8×8×10	8×8×10
HP:	20	20
RPM:	1800	1800
AB:	35.85(911)	41.64(1058)
B1:	12.00(305)	12.00(305)
B2:	11.50(292)	11.50(292)
C1:	20.58(523)	20.58(523)
C2:	21.02(534)	21.02(534)
D1:	21.00(533)	21.00(533)
D2:	25.00(635)	25.00(635)
E:	9.94(252)	8.90(226)
P:	13.38(340)	13.38(340)
F:	18.04(458)	21.44(545)
SD:	46.00(1168)	46.00(1168)
T:	8.75(222)	8.75(222)
XY:	34.13(867)	34.20(869)
Weight:	1642(744.8)	1690(766.6)

Performance curves are for reference only.
Confirm current performance data with Armstrong ACE Online selection software.

Dimensions - inch (mm)
Weight - lbs (kg)

INDOOR

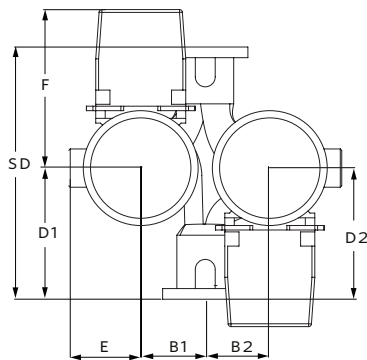

OUTDOOR

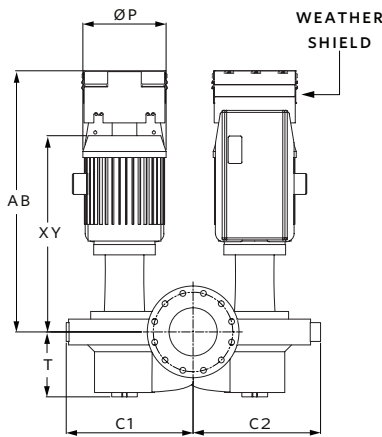
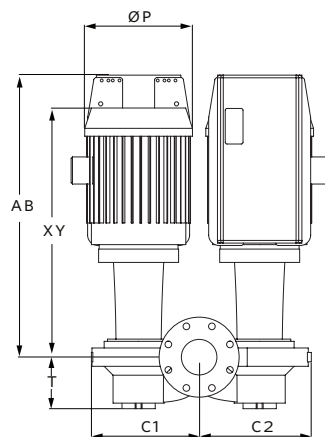
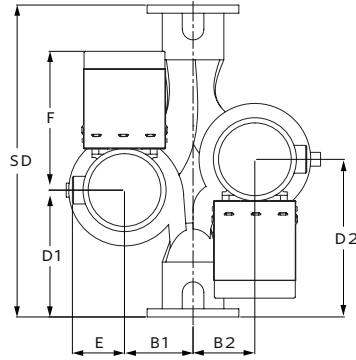

- Tolerance of ±0.125" (±3 mm) should be used
- For exact installation, data please write factory for certified dimensions

TORONTO

23 BERTRAND AVENUE
TORONTO, ONTARIO
CANADA, M1L 2P3
+1 416 755 2291

BUFFALO

93 EAST AVENUE
NORTH TONAWANDA, NEW YORK
U.S.A., 14120-6594
+1 716 693 8813

BIRMINGHAM

HEYWOOD WHARF, MUCKLOW HILL
HALESOWEN, WEST MIDLANDS
UNITED KINGDOM, B62 8DJ
+44 8444 145 145

MANCHESTER

WOLVERTON STREET
MANCHESTER
UNITED KINGDOM, M11 2ET
+44 8444 145 145

BANGALORE

#59, FIRST FLOOR, 3RD MAIN
MARGOSA ROAD, MALLESWARAM
BANGALORE, INDIA, 560 003
+91 80 4906 3555

SHANGHAI

UNIT 903, 888 NORTH SICHUAN RD.
HONGKOU DISTRICT, SHANGHAI
CHINA, 200085
+86 21 5237 0909

SÃO PAULO

RUA JOSÉ SEMIÃO RODRIGUES AGOSTINHO,
1370 GALPÃO 6 EMBU DAS ARTES
SAO PAULO, BRAZIL
+55 11 4785 1330

LYON

93 RUE DE LA VILLETTE
LYON, 69003 FRANCE
+33 4 26 83 78 74

DUBAI

JAFZA VIEW 19, OFFICE 402
P.O.BOX 18226 JAFZA,
DUBAI - UNITED ARAB EMIRATES
+971 4 887 6775

MANNHEIM

DYNAMOSTRASSE 13
68165 MANNHEIM
GERMANY
+49 621 3999 9858