

DESIGN ENVELOPE 4380 VIL | 0306-001.0 | SUBMITTAL

File No: 100.4314
Date: JANUARY 14, 2016
Supersedes: 100.4314
Date: AUGUST 14, 2015

Job: _____ Representative: _____

Order No: _____ Date: _____

Engineer: _____ Submitted by: _____ Date: _____

Contractor: _____ Approved by: _____ Date: _____

PUMP DESIGN DATA

No. of pumps: _____ Tag: _____

Capacity: _____ USgpm (L/s) Head: _____ ft (m)

Liquid: _____ Viscosity: _____

Temperature: _____ °F (°C) Specific gravity: _____

Suction: 3" (75mm) Discharge: 3" (75mm)

OSHPD Seismic Certification OSP-0422-10

UL STD 778 & CSA STD C22.2 NO.108 certified

MOTOR DESIGN DATA

hp: _____ rpm: _____ Frame size: _____ Enclosure: _____

Volts: _____ Hertz: 60 Hz Phase: 3

Efficiency: NEMA premium 12.12

MAXIMUM PUMP OPERATING CONDITIONS

ANSI 125

175 psig at 150°F (12 bars at 65°C)

140 psig at 250°F (10 bars at 121°C)

ANSI 250

300 psig at 150°F (20 bars at 65°C)

250 psig at 250°F (17 bars at 121°C)

- Tolerance of ±0.125" (±3 mm) should be used
- For exact installation, data please write factory for certified dimensions

MECHANICAL SEAL DATA

Seal type: 2A

Stationary seat: Silicone carbide

Secondary seal: EPDM

Rotating hardware: Stainless steel

Spring: Stainless steel

CONTROLS DATA

Sensorless control: Standard

Minimum system pressure to be maintained: _____ ft (m)*

Orientation: L1 (default) L2 L3 L4

Protocol (standard): Modbus RTU BACnet™ MS/TP
 Johnson® N2 Siemens® FLN

Protocol (optional): LonWorks®

Enclosure: Indoor - UL TYPE 12

Outdoor - UL TYPE 4X with weather shield

Outdoor - UL TYPE 4X less weather shield

Fused disconnect switch:

EMI/RFI control: Integrated filter designed to meet EN61800-3

Harmonic suppression: Dual DC-link reactors (equivalent: 5% AC line reactor) supporting IEEE 519-1992 requirements**

Cooling: Fan-cooled through back channel

Ambient temperature: -10°C to +45°C up to 1000 meters above sea level (-14°F to +113°F, 3300 ft)

Analog I/O: Two current or voltage inputs, one current output

Digital I/O: Six programmable inputs (two can be configured as outputs)

Pulse inputs: Two programmable

Relay outputs: Two programmable

Communication port: 1-RS485, 1-USB

*If minimum maintained system pressure is not known: Default to 40% of design head

**The IVS 102 drive is a low harmonic drive via built-in DC line reactors. This does not guaranty performance to any system wide harmonic specification or the costs to meet a system wide specification. If supplied with the system electrical details, Armstrong will run a computer simulation of the system wide harmonics. If system harmonic levels are exceeded Armstrong can also recommend additional harmonic mitigation and the costs for such mitigation.

FLUID TYPE	ALL GLYCOLS > 30% WT CONC		ALL OTHER NON-POTABLE FLUIDS		POTABLE (DRINKING) WATER	
Temperature	up to 200°F / 93°C	over 200°F / 93°C	up to 200°F / 93°C	over 200°F / 93°C	up to 200°F / 93°C	over 200°F / 93°C
Rotating face	Silicone carbide		Resin bonded carbon	Antimony loaded carbon	Resin bonded carbon	
Seat elastomer	EPDM (L-cup)	EPDM (O-ring)	EPDM (L-cup)	EPDM (O-ring)	EPDM (L-cup)	EPDM (O-ring)
Material code	SCSc L EPSS 2A	SCSc O EPSS 2A	C-SC L EPSS 2A	ACSc O EPSS 2A	C-SC L EPSS 2A	C-SC O EPSS 2A

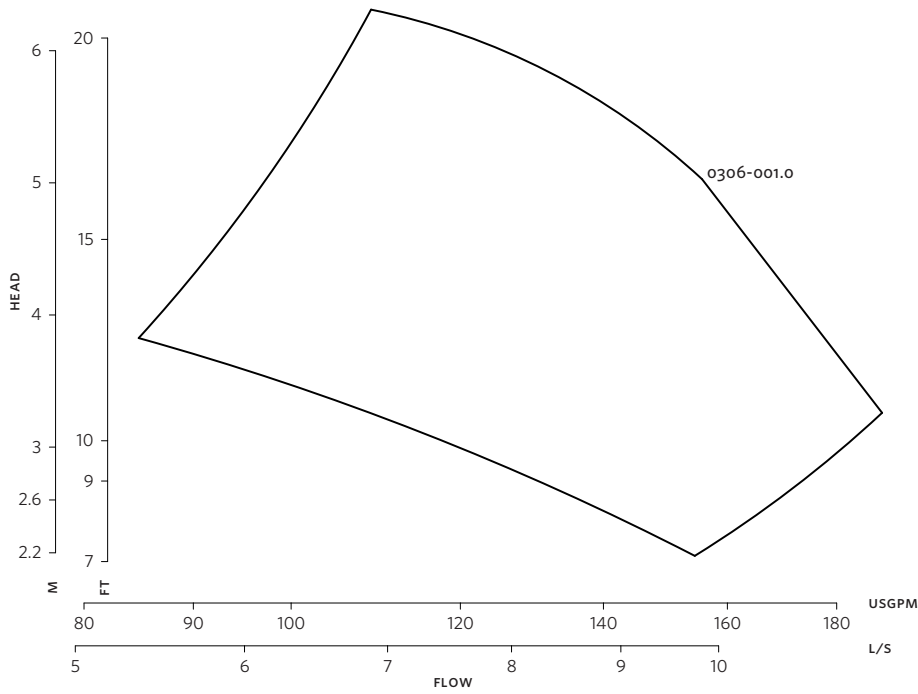

DIMENSION DATA

	INDOOR (UL TYPE 12/ODP)	OUTDOOR (UL TYPE 4X/TEFC)
Frame size:	143	143
Size:	3×3×6	3×3×6
HP:	1	1
RPM:	1800	1800
AB:	24.92(633)	30.88(784)
B:	5.80(147)	5.80(147)
C:	4.65(118)	4.65(118)
D:	8.25(210)	8.25(210)
E:	11.85(301)	17.12(435)
P:	8.63(219)	7.28(185)
F:	21.60(549)	26.87(682)
S:	9.75(248)	9.75(248)
SD:	18.00(457)	18.00(457)
T:	6.00(152)	6.00(152)
XY:	22.03(560)	20.53(521)
Weight:	232(105.2)	236(107.0)

Performance curves are for reference only.
Confirm current performance data with Armstrong ACE Online selection software.

Dimensions - inch (mm)
Weight - lbs (kg)

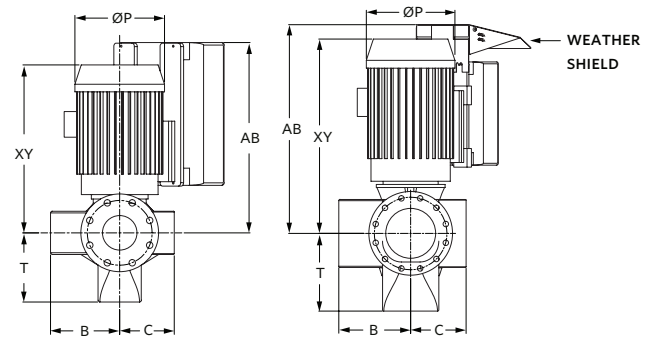
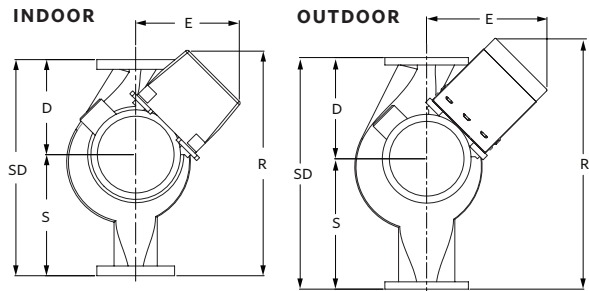
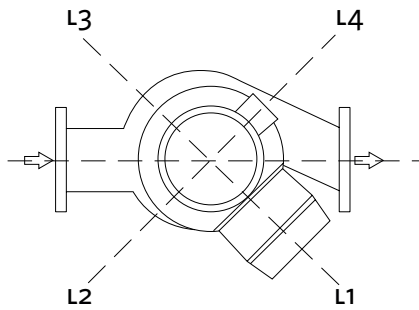

TORONTO
+1 416 755 2291

BUFFALO
+1 716 693 8813

BIRMINGHAM
+44 (0) 8444 145 145

MANCHESTER
+44 (0) 8444 145 145

BANGALORE
+91 (0) 80 4906 3555

SHANGHAI
+86 21 3756 6696